

THE SERPA® ADVANTAGE

[PATENTED 5,918,784 AND D501,991 OTHER PATENTS PENDING]

THUMB ACTIVATED PIVOT GUARD

SERPA AUTO LOCK TECHNOLOGY

PASSIVE RETENTION ADJUSTMENT SCREW



SERPA® TECHNOLOGY

This unique holster design allows you to forget old-fashioned thumb breaks that slow your draw and complicate re-holstering. The patented SERPA® Auto Lock Technology™ engages the trigger guard as you holster the pistol and won't let go until you release it. The release is made using your normal drawing motion, with the trigger finger beside the holster body. On the SERPA® Level 3 holster pictured, the pivot guard is quickly opened by thumb break activation. The pivot guard adds an extra level of retention and it will not close accidentally and lock you out of the holster.

SERPA TECHNOLOGY™ FEATURES:

- **Ergonomic Design**
Custom molded per weapon size
Reinforces proper hand position and draw technique
- **Commonality of Training**
Reinforces full master grip
Auto-lock position reinforces finger on frame
All platforms use common draw technique
- **Multiple Levels of Security**
Level II
Level III



**LEVEL 2
CONCEAL**
4105_



**LEVEL 2 SPORT-
STER**
4135_



**LEVEL 2
LIGHT BEARING**
41450_



**DUTY
44HO
TACTICAL**
4305_



**LEVEL 3
AUTO LOCK**
44H1
TACTICAL
4306_



**LEVEL 3
LIGHT BEARING
DUTY**
44H5
TACTICAL
4307_

THE SERPA® ADVANTAGE



1 Establish master grip on the weapon with the index finger extended



2 Lay the pad of the index finger on top of the SERPA® release. Apply pressure against the release with the extended index finger as you draw.



3 Draw the weapon normally and the index finger will locate itself on the weapon frame.

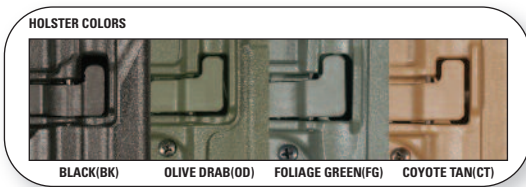

CONSTRUCTED OF A PROPRIETARY CARBON FIBER BLEND

- Lightweight
- Does not show wear or stress
- Not affected by heat or cold
- Not affected by chemicals
- Finish options match other gear
- Neat, clean, professional

ALL BLACKHAWK!® CQC® CONCEALMENT HOLSTERS INCLUDE BOTH BELT LOOP AND PADDLE PLATFORMS

BELT LOOP PLATFORMS

[PATENTED D507,104]

Our Carbon-Fiber Composite Belt Loop allows you to adjust to a variety of different angles so you can vary the cant of the holster from strong side to appendix carry and even cross-draw. The unique belt-slot adjustment tabs even allow you to adjust the width of the belt slots for different belt sizes. They can also be used to adjust the ride height of the holster, by placing them at the top or bottom end of the belt slot, allowing the belt to ride above or below the adjustment tabs.

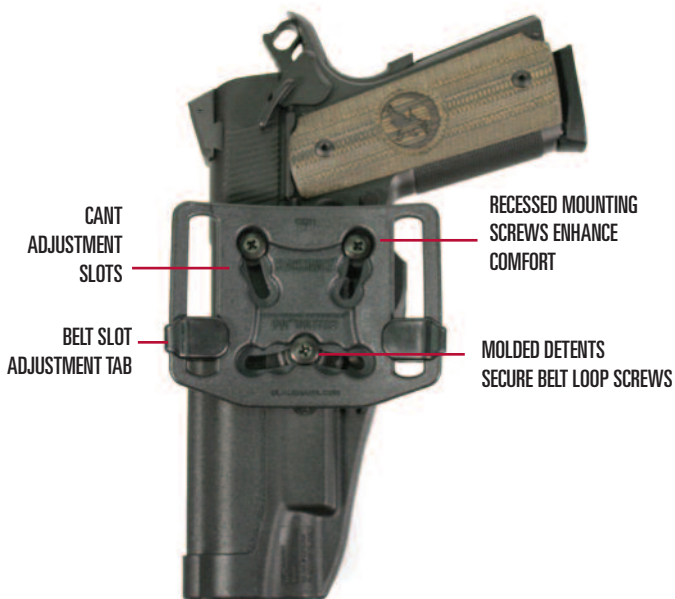

CANT ADJUSTMENT SLOTS

RECESSED MOUNTING SCREWS ENHANCE COMFORT

BELT SLOT ADJUSTMENT TAB

MOLDED DETENTS SECURE BELT LOOP SCREWS

ANGLE ADJUSTABLE PADDLE

[PATENTED D508,318]

Our user-friendly Carbon-Fiber Composite Paddle also allows you to vary the angle of cant through a full range of options. Butt forward for strong side or behind the hip carry, vertical for appendix carry or even muzzle forward for appendix or cross-draw positions.

Our unique paddle gives you a very stable platform for your holster and won't come out when drawing the handgun, thanks to adjustable retention hooks that ride under your waistband as well as the tension of the paddle. Yet it doesn't require unfastening your belt to remove the holster.



SERPA® CONCEALMENT HOLSTERS

MATTE FINISH



 ALL BLACKHAWK® CQC® SERPA TECHNOLOGY™ HOLSTERS COME WITH BOTH BELT LOOP AND PADDLE PLATFORMS.

 **SERPA® CQC CARBON-FIBER HOLSTER WITH SERPA ACTIVE RETENTION SYSTEM**
[PATENTED 5,918,784 AND D501,991 OTHER PATENTS PENDING]

This unique holster design allows you to forget old-fashioned thumb breaks that slow your draw and complicate re-holstering. The patented SERPA Technology lock™ engages the trigger guard as you holster the pistol and won't let go until you release it. The release is made using your normal drawing motion, with the trigger finger beside the holster body. The perfect retention holster for concealed carry. The weapon can't accidentally leave the holster.

SERPA TECHNOLOGY™ FEATURES:

- Full firing grip for draw and immediate retention upon re-holster
- No thumb break or awkward middle finger release to slow down your draw
- Speed cut allows faster draw and easy re-holster

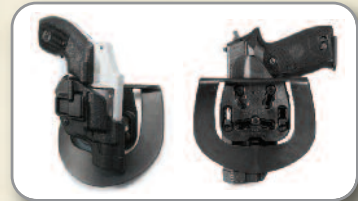

SERPA® CQC W/ MATTE FINISH

MODEL	COLOR	PART#	SIZE	MODEL	COLOR	PART#	SIZE
Glock 17/22 /31	Black	410500BK-L or R	00	Ruger P95	Black	410512BK-R	12
Glock 26/27/33	Black	410501BK-L or R	01	Glock 20/21/37 S&W/M&P .45 & 9/40 Pro	Black	410513BK-L or R	13
Glock 19/23/32/36	Black	410502BK-L or R	02	H&K USP Full Size	Black	410514BK-L or R	14
1911 Gov't & Clones with or w/out rail	Black	410503BK-L or R	03	H&K P-2000 LEFT HAND	Black	410509BK-L	09
1911 Gov't & Clones with or w/out rail	Coyote Tan	410503CT-L or R	03	H&K P-2000 RIGHT HAND	Black	410516BK-R	16
Beretta 92/96 (not Elite/Brig. or M9A1)	Black	410504BK-L or R	04	H&K P-30	Black	410517BK-L or R	17
Beretta 92/96 (not Elite/Brig. or M9A1)	Coyote Tan	410504CT-L or R	04	FN 5.7 (USG version)	Black	410518BK-L or R	18
Beretta 92/96 (not Elite/Brig. or M9A1)	Foliage Green	410504FG-L or R	04	Taurus 24/7 OSS	Black	410519BK-R	19 NEW!
Beretta 92/96 (not Elite/Brig. or M9A1)	Olive Drab	410504OD-L or R	04	S&W J-Frame 2" (not .357)	Black	410520BK-L or R	20
Sig 228/229/250DC with or w/out rail	Black	410505BK-R	05	Walther P99	Black	410524BK-L or R	24 NEW!
Sig 220/226/228/229 with or w/out rail	Black	410506BK-L	06	S&W MP 9/40 and Sigma (Sigma R only)	Black	410525BK-L or R	25
Sig 220/226/228/229 with or w/out rail	Coyote Tan	410506CT-L	06	Beretta PX 4 Storm	Black	410528BK-R	28 NEW!
Sig 220/226/225 with or w/out rail	Black	410506BK-R	06	Taurus 24/7	Black	410529BK-R	29
Sig 220/226/225 with or w/out rail	Coyote Tan	410506CT-R	06	Glock 29/30/39	Black	410530BK-R	30 NEW!
Springfield XD Compact and Service 4" barrels	Black	410507BK-L or R	07	Springfield XD Sub Comp.	Black	410531BK-R	31 NEW!
SigPro 2022	Black	410508BK-R	08	Taurus 85 2" 5-shot .38 only	Black	410532BK-R	32
H&K USP Compact	Black	410509BK-L or R	09	Glock 38	Black	410538BK-R	38 NEW!
S&W 5900/4000 9/40 series incl. TSW	Black	410510BK-L or R	10	Taurus Judge (2 1/2" Cylinder Model)	Black	410540BK-R	40
Ruger P85/89	Black	410511BK-R	11	Ruger SR9	Black	410541BK-R	41
				1911 Commander & Clones with or w/out rails	Black	410542BK-R	42

\$48.99

SERPA® CQC CONCEALMENT

CARBON FIBER APPLIQUE FINISH



SERPA® CQC W/CARBON FIBER APPLIQUE FINISH

[PATENTED 5,918,784 AND D501,991 OTHER PATENTS PENDING]



This unique holster design allows you to forget old-fashioned thumb breaks that slow your draw and complicate re-holstering. The patented SERPA Technology lock™ engages the trigger guard as you holster the pistol and won't let go until you release it. The release is made using your normal drawing motion, with the trigger finger beside the holster body. The perfect retention holster for concealed carry. The weapon can't accidentally leave the holster.

SERPA TECHNOLOGY™ FEATURES:

- Full firing grip for draw and immediate retention upon re-holster
- No thumb break or awkward middle finger release to slow down your draw
- Speed cut allows faster draw and easy re-holster

All BLACKHAWK!® CQC® SERPA Technology™ holsters come with both belt loop and paddle platforms.

MODEL	PART#	SIZE
Glock 17/22 /31	410000BK-L or R	00
Glock 26/27/33	410001BK-L or R	01
Glock 19/23/32/36	410002BK-L or R	02
1911 Gov't & Clones with or w/out rails	410003BK-L or R	03
Beretta 92/96 (not Elite/Brig. or M9A1)	410004BK-L or R	04
Sig 228/229/250DC with or w/out rails	410005BK-R	05
Sig 220/226/228/229 with or w/out rails	410006BK-L	06
Sig 220/225/226 with or w/out rails	410006BK-R	06
Springfield XD Compact or Service Models	410007BK-L or R	07
SigPro 2022	410008BK-R NSN# 1095-01-522-0425	08
H&K USP Compact	410009BK-L or R	09
H&K P-2000 LEFT/USP Compact	410009BK-L	09
H&K P-2000 RIGHT	410016BK-R	16
S&W 5900/4000 9/40 incl. TSW	410010BK-L or R	10
Ruger P85/89	410011BK-R	11
Ruger P95	410012BK-R	12
Glock 20/21/S&W/M&P .45 & 9/40 Pro	410013BK-L or R	13
H&K USP Full Size	410014BK-L or R	14
H&K P-30	410017BK-L or R	17 NEW!
FN 5.7 (USG version)	410018BK-L or R	18
Taurus 24/7 OSS	410019BK-R	19 NEW!
Walther P99	410024BK-L or R	24 NEW!
S&W MP9/40 and Sigma (Sigma R only)	410025BK-L or R	25
Beretta PX-4	410028BK-R	28 NEW!
Taurus 24/7	410029BK-R	29
Glock 29/30/39	410030BK-R	30 NEW!
Springfield XD Subcompact	410031BK-R	31 NEW!
Glock 38	410038BK-R	38 NEW!
Ruger SR9	410041BK-R	41
1911 Commander & Clones with or w/out rails	410042BK-R	42
	\$58.99	

SERPA® LEVEL 2 SPORTSTER



GUN METAL GREY

MODEL	PART#	SIZE
Glock 17/22/31	413500BK- L or R	00
Glock 26/27/33	413501BK- L or R	01
Glock 19/23/32/36	413502BK- L or R	02
1911 Gov't & Clones with or w/out rails	413503BK- L or R	03
BERETTA 92/96 (not Elite/Brig. or M9A1)	413504BK- L or R	04
SIG 228/229/250DC with or w/out rails	413505BK- R	05
SIG 220/225/226 with or w/out rails	413506BK- R	06
SIG 220/226/228/229 with or w/out rails	413506BK- L	06
Springfield XD Compact or Service Models	413507BK- R	07
H&K USP Compact	413509BK- R	09
H&K USP Compact/P-2000	413509BK- L	09
S&W 5900/4000 9/40 series incl. TSW	413510BK- L or R	10
GLOCK 20/21/37 S&W MP .45 & 9/40 Pro	413513BK- L or R	13
H&K USP FULL	413514BK- L or R	14
H&K P-2000	413516BK-R	16
FN 5.7 (USG version)	413518BK- L or R	18
S&W J-frame rvlvr 2" (not .357)	413520BK- L or R	20
S&W M&P 9/40 and Sigma	413525BK- L or R	25

\$32.99



FOR HIGH THREAT LEVEL ENVIRONMENT USE THE ORIGINAL SERPA!



SERPA® CQC® SPORTSTER HOLSTER

- Gun metal gray holster body with black SERPA mechanism
- Developed for civilian concealed carry and range use, but still has the great patented SERPA design
- Traditional polymer material construction found in other injection molded holsters
- Paddle and traditional polymer for civilian, concealed carry and range use
- Comes with paddle mount only

SERPA® CQC LIGHT BEARING FOR XIPHOS NT



SERPA AUTO LOCK TECHNOLOGY



PASSIVE RETENTION ADJUSTMENT SCREW



Finally a weapon light and holster combo that makes it practical to carry a light on a concealed handgun. The slim profile of the Xiphos NT light means that there is no added bulk away from your body.

SERPA CQC FOR XIPHOS

MODEL	PART#	SIZE
GLOCK 17/22/31	414500BK-R	00
1911 Gov't & Clones with or w/out rail	414503BK-R	03
Sig 220/226	414506BK-L or R	06

\$48.99



Holster works with the Xiphos NT Weapon Mountable light. Light Not Included w/Holster SEE PAGE 75

ASK YOUR PARTICIPATING DEALER FOR BLACKHAWK! TRADE-UP DETAILS

SERPA® LEVEL 2 DUTY HOLSTERS

BLACKHAWK!

HOLSTERS



MATTE FINISH



SERPA® LEVEL 2 AUTO LOCK™ DUTY HOLSTER

Based on our popular Tactical SERPA Holster, this jacket slot belt loop version gives both the tactical and patrol officer the option of the SERPA's retention and speed in a duty style holster. Whether worn as part of your duty rig, or as a belt mounted holster for tactical use, you get the same great SERPA system, now in a duty holster.

SERPA® LEVEL 2 AUTO LOCK™ DUTY HOLSTER - BLACK

MODEL	PART#	SIZE
GLOCK 17/19/22/23/31/32	44H00BK-R	00
GLOCK 17/19/20/21/22/23/31/32/40/45 AND S&W M&P	44H00BK-L	00
1911 GOV'T AND CLONES WITH OR WITHOUT PICATINNY RAILS	44H003BK-L or R	03
BERETTA 92/96 - NOT FOR BRIGADIER/ELITE OR M9A1	44H004BK-L or R	04
SIG 220/225/226/228/229 WITH OR WITHOUT PICATINNY RAIL	44H006BK-L or R	06
SIGPRO 2022	44H008BK-L or R	08
GLOCK 20/21/37/38 AND S&W M&P .45 AND PRO 9/40	44H013BK-R	13
GLOCK 21SF W/LARGER 1913 RAIL	44H026BK-R	26

\$82.99

FULL LENGTH HOLSTER BODY
PROTECTS REAR SIGHTS

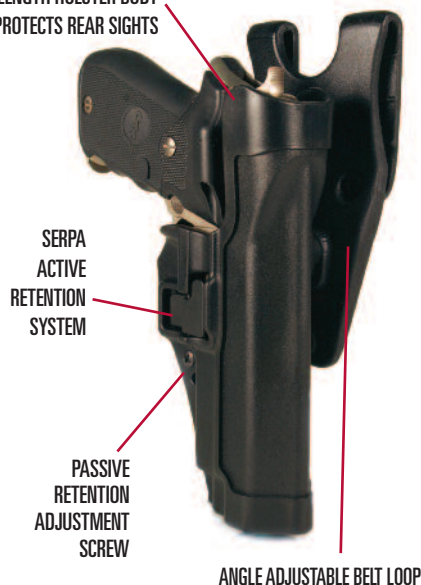

SERPA
ACTIVE
RETENTION
SYSTEM

PASSIVE
RETENTION
ADJUSTMENT
SCREW

ANGLE ADJUSTABLE BELT LOOP

www.BLACKHAWK.com 800.694.5263

SERPA® TASER X-26 HOLSTER



SERPA X-26 TASER® HOLSTER

The SERPA Active Retention System has now been adapted for the TASER® X-26. This design incorporates our Detachable Belt Loop, so that officers can exchange the TASER® between shifts without having to remove other items from the duty belt. Also fits all SERPA® platforms, including duty belt loops, MOLLE, shoulder and tactical thigh platforms. The multi-draw design and rock forward draw, versus traditional straight draw, help prevent confusing weapons under stress. The holster is even designed to automatically engage the safety when re-holstering the TASER®.

The holster design stabilizes the X-26 even with the optional camera unit attached. The holster's bottom is configured to block the probes in case of activation within the holster. The trigger and trigger guard are completely enclosed while the TASER® is holstered.

- Popular SERPA design adapted for TASER®s with multi-draw design
- Belt loop design allows officers to exchange TASER® without removing other gear
- Different draw than pistol holsters to help prevent confusion under stress
- Belt loop also fits most duty belts
- Design automatically engages safety when re-holstering
- Available in matte-black, basketweave and plain black finishes
- Designed to retain probes if activated while still in holster
- Completely covered trigger when holstered
- TASER® fully stabilized even with camera unit attached
- Fits all SERPA® platforms: duty belt loops, MOLLE and Tactical Thigh Platforms
- Protects cartridge in holster



MODEL	PART#	SIZE	
L2 SERPA DUTY HOLSTER TASER - MATTE FINISH	44H015BK-L or R	15	\$49.99
L2 SERPA DUTY HOLSTER TASER - BASKETWEAVE FINISH	44H015BW-L or R	15	\$59.99
L2 SERPA DUTY HOLSTER TASER - PLAIN FINISH	44H015PL-L or R	15	\$59.99

SERPA® LEVEL 3 DUTY HOLSTERS



BASKETWEAVE FINISH



SERPA LEVEL 3 AUTO LOCK™ DUTY HOLSTER

Level 3 retention holsters have long been the standard for law enforcement duty use. The problem has been that many holsters that provide this level of protection are clumsy to operate and can prevent the officer from drawing his weapon rapidly under stress. The Level 3 SERPA Auto Lock holster uses your natural drawing motion to release the weapon. No unnatural motions or complicated sequences to remember, just grab and draw using gross motor skills.

- SERPA Auto Lock System provides a quick, natural draw with immediate security upon re-holstering to increase officer safety
- Injection molded carbon fiber composite construction provides incredible strength
- Extremely light weight
- No snaps or hoods to accidentally open. Weapon stays secured until you decide to draw
- Ease of training, same drawing technique for undercover, tactical and duty

PLAIN APPLIQUE FINISH

MODEL	PART#	SIZE
GLOCK 17/19/22/23/31/32	44H100PL-R or L	00
1911 GOV'T & CLONES with or without rail	44H103PL-R	03 NEW!
BERETTA 92/96/M9A1	44H104PL-R or L	04 NEW!
SIG 220/225/226/228/229 with or without rail	44H106PL-R or L	06
GLOCK 20/21/21SF/37/38 and S&W M&P .45 and MP Pro	44H113PL-R or L	13
H&K USP COMPACT / P2000 (EURO) 9/40	44H109PL-R or L	09 NEW!
H&K P2000 (US)	44H116PL-R or L	16 NEW!
H&K FULL SIZE USP	44H114PL-R or L	14 NEW!
H&K P30	44H117PL-R or L	17
SMITH AND WESSON M&P 9/40	44H125PL-R or L	25

\$118.99

MATTE FINISH

MODEL	PART#	SIZE
GLOCK 17/19/22/23/31/32	44H100BK-R or L	00
1911 GOV'T & CLONES with or without rail	44H103BK-R	03 NEW!
BERETTA 92/96/M9A1	44H104BK-R or L	04
SIG 220/226/228/229 with or without rail	44H106BK-R or L	06
SIG PRO 2022	44H108BK-R or L	08 NEW!
H&K USP COMPACT/P2000 (EURO)	44H109BK-R or L	09 NEW!
GLOCK 20/21/21SF/37/38 and S&W M&P .45 and MP Pro	44H113BK-R or L	13
H&K P2000 (US)	44H116BK-R or L	16 NEW!
H&K FULL SIZE USP - MATTE FINISH	44H114BK-R or L	14
H&K P30	44H117BK-R or L	17
WALTHER P99	44H124BK-R or L	24 NEW!
SMITH AND WESSON M&P 9/40	44H125BK-R or L	25

\$102.99

Pivot Guard won't close accidentally and prevent you from reholstering your pistol

BASKETWEAVE FINISH

MODEL	PART#	SIZE
GLOCK 17/19/22/23/31/32	44H100BW-R or L	00
1911 GOV'T & CLONES with or without rail	44H103BW-R	03 NEW!
BERETTA 92/96/M9A1	44H104BW-R or L	04 NEW!
SIG 220/225/226/228/229 with or without rail	44H106BW-R or L	06
GLOCK 20/21/21SF/37/38 and S&W M&P .45 and MP Pro	44H113BW-R or L	13
H&K P2000 (US)	44H116BW-R or L	16 NEW!
H&K USP COMPACT / P2000 (EURO)	44H109BW-R or L	09 NEW!
H&K FULL SIZE USP	44H114BW-R or L	14
H&K P30	44H117BW-R or L	17
SMITH AND WESSON M&P 9/40	44H125BW-R or L	25

\$118.99



NATURAL GRIP RELEASE



ATTACHES TO BELT WITHOUT HAVING TO REMOVE THE BUCKLE OR POUCHES



MATTE FINISH



PLAIN APPLIQUE FINISH

SERPA® LEVEL 3 LIGHT BEARING DUTY HOLSTERS



SERPA LEVEL 3 LIGHT BEARING DUTY HOLSTER

(XIPHOS™ NT LIGHT)

Finally an answer to the thousands of requests we have received for a SERPA duty holster that works with a pistol light. Now you can get the Level 3 SERPA holster, noted for its speed and retention, to wear with our Xiphos light while you are on duty. Outstanding retention, extremely fast draw even under stress and immediate lock-in upon reholstering.

MATTE FINISH

MODEL	PART#	SIZE
BERETTA 92/96/M9A1	44H504BK-R	04 NEW!
GLOCK 17/19/22/23/31/32	44H500BK-L or R	00
GLOCK 20/21/37/38 & SW MP.45 & 9/40 PRO	44H513BK-L or R	13 NEW!
H&K P-2000 (US)	44H516BK-L or R	16 NEW!
SIG 220/225/226 with or without rail	44H506BK-L or R	06 NEW!
\$102.99		

BERETTA 92/96/M9A1	44H504BW-R	04 NEW!
GLOCK 17/19/22/23/31/32	44H500BW-L or R	00
GLOCK 20/21/37/38 & SW MP.45 & 9/40 PRO	44H513BW-L or R	13 NEW!
H&K P-2000 (US)	44H516BW-R	16 NEW!
SIG 220/225/226 with or without rail	44H506BW-L or R	06 NEW!
\$118.99		

BERETTA 92/96 (not Elite or Brig.)	44H504PL-R	04 NEW!
GLOCK 17/19/22/23/31/32	44H500PL-L or R	00
GLOCK 20/21/37/38 & SW MP.45 & 9/40 PRO	44H513PL-L or R	13 NEW!
H&K P-2000 (US)	44H516PL-L or R	16 NEW!
SIG 220/225/226 with or without rail	44H506PL-L or R	06 NEW!
\$118.99		

HOLSTER + LIGHT

SERPA LEVEL 3 LIGHT BEARING DUTY HOLSTER & XIPHOS NT LIGHT COMBO

Get both the Level 3 SERPA Duty Holster and the Xiphos NT light in one package. Bundled together for convenience, this package gives you everything you need for your duty weapon.

SPECIAL COMBO PRICE!

MATTE FINISH

HOLSTER FOR GLOCK 17/19/22/23/31/32 PLUS XIPHOS NT LIGHT	44H600BK-L or R	
GLOCK 20/21/37/38 & SW MP.45 & 9/40 PRO PLUS XIPHOS NT LIGHT	44H613BK-L or R NEW!	
H&K P-2000 (US) HOLSTER W/XIPHOS NT LIGHT	44H616BK-R NEW!	
SIG 220/225/226 with or without rail	44H606BK-L or R NEW!	
\$259.99		

BASKETWEAVE FINISH

HOLSTER FOR GLOCK 17/19/22/23/31/32 PLUS XIPHOS NT LIGHT	44H600BW-L or R	
GLOCK 20/21/37/38 & SW MP.45 & 9/40 PRO PLUS XIPHOS NT LIGHT	44H613BW-L or R NEW!	
H&K P-2000 (US) HOLSTER PLUS XIPHOS NT LIGHT	44H616BW-R NEW!	
SIG 220/225/226 with or without rail	44H606BW-L or R NEW!	
\$274.99		

PLAIN FINISH

HOLSTER FOR GLOCK 17/19/22/23/31/32 PLUS XIPHOS NT LIGHT	44H600PL-L or R	
GLOCK 20/21/37/38 & SW MP.45 & 9/40 PRO PLUS XIPHOS NT LIGHT	44H613PL-L or R NEW!	
H&K P-2000 (US) HOLSTER W/XIPHOS NT LIGHT PLUS XIPHOS NT LIGHT	44H616PL-R NEW!	
SIG 220/225/226 with or without rail	44H606PL-L or R NEW!	
\$274.99		



MATTE FINISH



Xiphos NT Weapon Mountable light



ASK YOUR PARTICIPATING DEALER FOR BLACKHAWK! TRADE-UP DETAILS



THUMB ACTIVATED PIVOT GUARD

SERPA AUTO LOCK TECHNOLOGY

HOUSES XIPHOS WEAPON MOUNTED LIGHT

PASSIVE RETENTION ADJUSTMENT SCREW

SERPA® TACTICAL LEVEL 2 HOLSTERS



COYOTE TAN HOLSTER

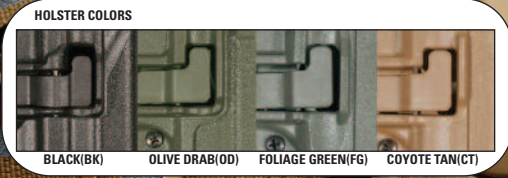

USA SERPA® TACTICAL LEVEL 2 HOLSTER

- Durable Carbon-Fiber Composite material
- High platform designed for breathability and conforms/molds to leg size
- Y-Harness suspension distributes weight for load comfort
- Swivel buckles on belt loops allow articulation for maximum flexibility
- SERPA® lock secures weapon until ergonomically released by simple indexing of finger using gross motor skills
- Drawing and reholstering is done with full master grip on weapon
- Passive Retention Adjustment Screw for additional security
- Hole in holster body for bungee retention if desired
- Patent 5,918,784 and other patents pending

MODEL	COLOR	PART# NSN#	SIZE
GLOCK 17/19/22/23/31/32	BLACK	430500BK-R	NSN# 1095-01-533-3013 00
GLOCK 17/19/20/21/22/23/31/32/S&W M&P 9/40/45	BLACK	430500BK-L	00
1911 GOV'T AND CLONES W/OR W/OUT RAILS	BLACK	430503BK-L OR R	03
1911 GOV'T AND CLONES W/OR W/OUT RAILS	COYOTE TAN	430503CT-L OR R	03
1911 GOV'T AND CLONES W/OR W/OUT RAILS	OLIVE DRAB	430503OD-L OR R	03
BERETTA (92/96) (NOT ELITE, BRIGADIER OR M9A1)	BLACK	430504BK-L OR R	NSN# 1095-01-533-3010 04
BERETTA (92/96) (NOT ELITE, BRIGADIER OR M9A1)	COYOTE TAN	430504CT-L OR R	NSN# 1095-01-533-3009 04
BERETTA (92/96) W/USMC MEDALLION (NOT ELITE, BRIGADIER OR M9A1)	COYOTE TAN	430504CT-L OR R-USMC	04
BERETTA (92/96) (NOT ELITE, BRIGADIER OR M9A1)	FOLIAGE GREEN	430504FG-L OR R	04
BERETTA (92/96) FG, W/US MEDALLION (NOT ELITE, BRIGADIER OR M9A1)	FOLIAGE GREEN	430504FG-L OR R-ARMY	04
BERETTA (92/96) (NOT ELITE, BRIGADIER OR M9A1)	OLIVE DRAB	430504OD-L OR R	04
SIG 220/225/226/228/229	BLACK	430506BK-L OR R	06
SIG 220/225/226/228/229	COYOTE TAN	430506CT-L OR R	06
SIG 220/225/226/228/229	OLIVE DRAB	430506OD-L OR R	06
SIG PRO 2022	BLACK	430508BK-L OR R	08
GLOCK 20/21/21SF/37/38/S&W M&P	BLACK	430513BK-R	13
GLOCK 21SF W/LARGER 1913 RAIL ONLY	BLACK	430526BK-R	26

\$129.99

SERPA® TACTICAL LEVEL 3 HOLSTERS



TACTICAL MAG POUCHES NOT INCLUDED



SERPA® TACTICAL LEVEL 3 HOLSTER

The speed and retention of the Level 3 SERPA has been joined with our patent-pending Y-Harness leg platform that gives greater stability and comfort than any other leg platform on the market. The SERPA Auto Lock System locks the pistol into the holster immediately upon reholstering.

LEVEL 3 TAC SERPA HOLSTER

MODEL	PART#	SIZE
GLOCK 17/19/22/23/31/32	430600BK-L or R	00
1911 GOV'T & CLONES W/ OR W/OUT RAIL	430603BK-R	03 NEW!
BERETTA 92/96 M9A1 (BLACK)	430604BK-L or R	04
BERETTA 92/96 M9A1 (FOLIAGE)	430604FG-L or R	04
SIG 220/225/226/228/229 W/ OR W/O RAIL	430606BK-L or R	06
SIG PRO 2022 (BLACK)	430608BK-L or R	08 NEW!
H&K USP COMPACT/P2000 (EURO)	430609BK-L or R	09 NEW!
GLOCK 20/21/37/38 M&P .45 AND PRO 9/40	430613BK-L or R	13
H&K FULL SIZE USP	430614BK-L or R	14
H&K P-2000 (US)	430616BK-L or R	16 NEW!
H&K P-30	430617BK-L or R	17 NEW!
WALTHER P-99	430624BK-L or R	24 NEW!
SMITH & WESSON MP 9MM & .40 CAL	430625BK-L or R	25

\$152.99



FOR ACCESSORY POUCHES SEE PG 123

SERPA® LEVEL 3 LIGHT BEARING TACTICAL HOLSTERS



FOR ACCESSORY POUCHES SEE PG 123



Finally an answer to the thousands of requests we have received for a Tac SERPA holster that works with a pistol light. Now you can get the Level 3 SERPA holster, noted for its speed and retention, to wear with a light while you are involved in tactical operations. Outstanding retention, extremely fast draw even under stress and immediate lock-in upon reholstering. Now you can have it all. Fits Xiphos™ NT LIGHT.

SERPA LEVEL 3 LIGHT BEARING TACTICAL HOLSTER (XIPHOS NT LIGHT ONLY)

MODEL	COLOR	PART#	SIZE
GLOCK 17/19/22/23/31/32	BLACK	430700BK-L or R	00
BERETTA 92/96 (NOT ELITE OR BRIG)	BLACK	430704BK-R	04
BERETTA 92/96 (NOT ELITE OR BRIG)	FOLIAGE	430704FG-R	04 NEW!
SIG 220/226 W/ OR W/OUT RAIL	BLACK	43706BK-L or R	06 NEW!
GLOCK 20/21/37/38 & SW MP.45 AND PRO 9/40	BLACK	430713BK-L or R	13 NEW!
H&K P2000 (US)	BLACK	430716BK-L or R	16 NEW!

\$152.99

HOLSTER & XIPHOS WEAPON LIGHT COMBO

Now you can get both the Level 3 SERPA Tactical Holster and the Xiphos Weapon Light in one package. Bundled together for convenience, this package gives you everything you need for your handgun in a tactical situation.

SAVE \$50 SPECIAL COMBO PRICE

SERPA LEVEL 3 LIGHT BEARING TACTICAL HOLSTER INCLUDING XIPHOS NT WEAPON LIGHT

MODEL	COLOR	PART#	SIZE
GLOCK 17/19/22/23/31/32	BLACK	430800BK-L or R	00
BERETTA 92/96 (NOT ELITE OR BRIG)	BLACK	430804BK-R	04 NEW!
BERETTA 92/96 (NOT ELITE OR BRIG)	FOLIAGE	430804FG-R	04 NEW!
SIG 220/226 W/ OR W/OUT RAIL	BLACK	430806BK-L or R	06 NEW!
GLOCK 21/37/38 & SW MP.45 AND PRO 9/40	BLACK	430813BK-L or R	13 NEW!
H&K P2000 (US)	BLACK	430816BK-L or R	16 NEW!

\$304.99



ASK YOUR PARTICIPATING DEALER FOR BLACKHAWK! TRADE-UP DETAILS

STANDARD CQC CONCEALMENT HOLSTERS



"The CQC® standard holster is the fastest belt mounted holster I have ever used!"
— Todd Jarrett
World Champion Shooter

CARBON FIBER APPLIQUE FINISH



PASSIVE
RETENTION
ADJUSTMENT
SCREW

MATTE FINISH



STANDARD CQC® CONCEALMENT HOLSTER WITH PRESSURE ADJUSTABLE DETENT

Our amazing Carbon-Fiber Composite holster gives you the most advanced material available for a holster, with a tension-adjustable passive retention system that allows you to select the amount of retention on your gun. Our system uses a passive retention adjustment screw that grabs the trigger guard of your pistol.

- A cut down body & tapered trailing edge aid in concealment
- Passive retention adjustment screw allows you to select level of retention
- Speed cut allows for fast draw and easy re-holster

All BLACKHAWK!® CQC® Carbon-Fiber Holsters include both Belt Loop and Paddle Platforms

STANDARD MODEL MATTE FINISH BLACK

MODEL	PART#	SIZE
Glock 17/22/31	415500BK-L or R	00
Glock 26/27/33	415501BK-L or R	01
Glock 19/23/32/36	415502BK- L or R	02
1911 Gov't & Clones with or w/out rail	415503BK-R	03
Beretta 92/96 (not Elite/Brig. or M9A1)	415504BK-R	04
Sig 228/229/250DC with or w/out rails	415505BK-R	05
Sig 220/225/226 with or w/out rails	415506BK-R	06
Springfield XD Compact or Service	415507BK-R	07
H&K USP Compact	415509BK-R	09
	\$35.99	

STANDARD MODEL CARBON FIBER FINISH BLACK

MODEL	PART#	NSN#	SIZE
Glock 17/22/31	415000BK-L		00
Glock 17/22/31	415000BK-R	NSN# 1095-01-522-0425	00
Glock 26/27/33	415001BK-L or R		01
Glock 19/23/32/36	415002BK-L		02
Glock 19/23/32/36	415002BK-R	NSN# 1095-01-522-1015	02
1911 Gov't & Clones with or w/out rail	415003BK-R		03
Beretta 92/96 (not Elite/Brig. or M9A1)	415004BK-R		04
Sig 228/229/250DC with or w/out rails	415005BK-R		05
Sig 220/225/226 with or w/out rails	415006BK-R		06
Springfield XD Compact or Service	415007BK-R		07
H&K USP Compact	415009BK-R		09
	\$45.99		

SERPA® HOLSTER PLATFORMS



TACTICAL HOLSTER PLATFORM WHERE COMFORT MEETS SPEED:

The Tactical Holster Platform allows you to take your CQC® Carbon-Fiber or BHLE Duty SERPA Holster and mount it to the THP, giving you a tactical option for your holster. Designed with the SERPA™ Holster in mind, this platform gives the professional the option of wearing the SERPA® Holster on the leg when needed for raids or other special operations.

- Patents Pending
- Attach BLACKHAWK! Law Enforcement™ Duty Gear belt pouches **See page(s) 126-134**
- Works with CQC Concealment SERPA or BHLE Duty SERPA Holsters

TACTICAL HOLSTER PLATFORM

432000P_FG, OD, CT, BK

\$64.99



FOR ACCESSORY POUCHES SEE PG 123

UNIQUE Y-HARNESSES DISTRIBUTES WEIGHT
EVENLY WITHOUT BINDING



QUICK
DISCONNECT
SWIVEL MOUNTS

DUAL NON-SLIP
LEG STRAPS

FLEXIBLE
PLATFORM

SERPA S.T.R.I.K.E.® CQC® PLATFORM

- Injection molded ambidextrous S.T.R.I.K.E adapter platform
- Hole pattern allows operator to mount any CQC holster at any of four carry angles
- Rails can also be mounted on this platform to accommodate any rail-mounted accessory (mag cases, light cases, knife sheaths, etc.)
- Mount your holster on any S.T.R.I.K.E. or MOLLE gear (vests, drop leg platforms, packs, etc.)
- Patent Pending

38CL63_FG, OD, CT, BK **\$15.99**

S.T.R.I.K.E. CQC PLATFORM WITH SERPA HOLSTER™

FOR BERETTA (PATENT 5,918,784 AND D501,991 AND OTHER PATENTS PENDING)

- Kit that combines the CQC SERPA Beretta 92/96 (not Elite or Brigadier) holster on the unique injection molded S.T.R.I.K.E adapter platform
- High density carbon-fiber polymer material
- Mount your pistol on any S.T.R.I.K.E. or MOLLE gear
- Holster adjusts to any angle

40CL01_FG, OD, CT, -L or R

NSN# 1095-01-533-3012 \$52.99





SHOULDER HARNESS FOR SERPA® HOLSTER PLATFORM

Due to customer demand for a way to use the popular SERPA™ Retention Holster as a shoulder rig, we have developed this comfortable shoulder harness platform. Made with a tapered web harness that adjusts for size and an offside dual Picatinny Rail Platform™ for any of our Picatinny Rail System™ accessories.

Shoulder harnesses (Black Only) sized to fit from Medium to XXX-L torsos. Also available for both right and left hand.

- Mount your SERPA holster on the underarm platform in a horizontal position.
- Secure carry and natural drawing motion
- Enables one-handed re-holstering
- Made for both medium and large frame torso individuals

SHOULDER HARNESS W/PLATFORM BLACK

MEDIUM = MD, FITS M-XL SHIRT, LARGE = LG, FITS L-XXXL

SHIRT		
41SH00BK		Medium
41SH00BK-L	Left	Medium
41SH01BK		Large
41SH01BK-L	Left	Large

\$56.99



HOLSTER NOT INCLUDED



SERPA® S.T.R.I.K.E.® COMBO KIT (BERETTA ONLY)

The STRIKE platform mounts securely to your MOLLE vest, while the shoulder harness, thigh platform and belt loop give you the option to wear the SERPA back at the base or when you don't need your MOLLE gear. Holsters and platforms are available in both Foliage Green and Coyote Brown. Shoulder harnesses (Black Only) sized to fit from Medium to XXX-L torsos. Also available for both right and left hand.

This kit offers soldiers the ability to wear your Beretta everywhere they go.

(BERETTA ONLY) (not Elite or Brigadier)

S.T.R.I.K.E. SERPA + BELT + SHOULDER + THIGH MOUNTS

FITS MEDIUM-LARGE TORSO

COYOTE TAN 40SC02CT-L or R

FOLIAGE GREEN 40SC02FG-L or R

\$175.99

(BERETTA ONLY) (not Elite or Brigadier)

S.T.R.I.K.E. SERPA + BELT + SHOULDER + THIGH MOUNTS

FITS LARGE - XXXL TORSO

COYOTE TAN 40SC03CT-L or R

FOLIAGE GREEN 40SC03FG-L or R

\$175.99

SHOULDER MOUNT



BELT MOUNT

S.T.R.I.K.E. PLATFORM



THIGH MOUNT

ALL-IN-ONE KIT FOR BERETTA!



CQC® CONCEALMENT CARBON-FIBER MULTI-FUNCTIONAL BELT LOOP

[available For Glock Model Holsters Only] [Patents Pending]

This Clever Belt Loop Turns Your BLACKHAWK!® CQC Carbon-Fiber Holster into a semi-pancake holster, with its' 3-slot design and width adjustable belt slots. You can choose to wear it as a cross-draw, appendix or strong side holster and the adjustable belt slots allow you to tune the angle of carry even more and adjust the slots for different belt widths.

SLOT WIDTH ADJUSTMENT CAN DETERMINE RIDE/HEIGHT



MULTI-FUNCTION BELT LOOP MATTE FINISH

410900CBK \$22.99



CONCEALMENT VEST HOLSTER PLATFORM

This Nylon Hook backed mounting platform allows you to mount the SERPA holster inside the Nylon Loop lined compartment of many popular fanny packs, concealment vests, or one of our many BLACKHAWK! carry bags.



HOLSTER NOT INCLUDED

CONCEALMENT VEST PLATFORM

411500BK Black \$18.99



CARBON FIBER HOLSTER SPACER KITS

This two-piece spacer kit allows you to adjust the amount of angle away from the body on any of our Carbon-Fiber Composite holsters. Whether you need to compensate for bulky body armor or hip-to-waist contours. Choose a little or a lot of adjustment.



CARBON FIBER CONCEALMENT HOLSTER SPACER KIT (PAIR)

• Includes 8-32 screws to work with "concealment" holsters
411400CBK Black \$15.99

TAC/DUTY SPACER KIT (SINGLE)

• Includes 10-32 screws for tactical and duty holsters
411401CBK Black \$10.99



BUNGEE



SERPA® HOLSTER BUNGI RETENTION STRAP

- High strength shock cord provides additional retention during extreme ops
- Great for 3 gun matches
- Secure it to your holster with a girth-hitch or knot and snap over pistol back strap
- Attach to any holster and cut to length

BUNGI RETENTION STRAP

40BRO0BK BLACK \$9.99

OPTIONAL PLATFORMS



**SERPA® PADDLE PLATFORM W/ SCREWS
FOR CONCEALMENT HOLSTER USE ONLY**
410902BK \$13.99



**SERPA® BELT LOOP PLATFORM W/SCREWS
FOR CONCEALMENT HOLSTER USE ONLY**
410901BK \$11.99



**SERPA® HIGH RIDE DUTY BELT LOOP
WITH DUTY HOLSTER SCREWS**

- Works with 2" and 2 1/4" duty belts
- This belt loop attachment allows you to move your holster higher on your duty belt

FOR DUTY HOLSTER USE ONLY
44H900BK \$13.99



SERPA® S.T.R.I.K.E. PLATFORM

- High density carbon-fiber polymer material
- Secures holsters, rails, and carbon-fiber accessories such as light and magazine cases
- Can be mounted to any S.T.R.I.K.E. or MOLLE platform; vests, belts, drop leg platform, packs, internal panels in some cases and packs

38CL63__ COLOR BK, CT, FG, OD \$15.99



SERPA® SHOULDER HARNESS

- SERPA holster mounts on the underarm platform in a horizontal position
- Made for both medium and large framed torsos

RIGHT HAND LARGE	41SH01BK	\$56.99
LEFT HAND LARGE	41SH01BK-L	\$56.99
RIGHT HAND MEDIUM	41SH00BK	\$56.99
LEFT HAND MEDIUM	41SH00BK-L	\$56.99



**SERPA® JACKET SLOT DUTY BELT LOOP W/
DUTY HOLSTER SCREWS**

- Works with 2" and 2 1/4" duty belts
- Screws can be removed from the belt loop opening, allowing the holster to be placed on the duty belt without unthreading other gear

FOR DUTY HOLSTER USE ONLY
44H901BK \$17.99



**SERPA® MID RIDE DUTY BELT LOOP WITH
DUTY HOLSTER SCREWS**

- Works with 2" and 2 1/4" duty belts
- This belt loop attachment allows you to move your holster higher on your duty belt

FOR DUTY HOLSTER USE ONLY
44H902BK **NEW!** \$17.99



**SERPA® MOD-U-LOK PLATFORM WITH
SCREWS**

The Quick Disconnect Belt Loop allows one handed release from belt without removing other items from the belt as needed with slide on design belt loops. Positive engagement keeps the belt loop on once you have attached it. Works with all CQC SERPA holsters and fits belts up to 2 1/4 inches wide and includes a spacer that adjusts for use with narrower belts.

410904BK \$18.99



SERPA® QUICK DISCONNECT SYSTEM

EASILY MOUNT THE QUICK DISCONNECT TO THE BACK OF ANY SERPA HOLSTER

From the dropleg tactical to the SERPA vest mount platform, the quick disconnect system allows you to quickly and easily move your SERPA holster between any SERPA platform. Instantly adjust your gear as your mission requires. The quick disconnect system allows the holster to be mounted in any of the 360 degree angles.

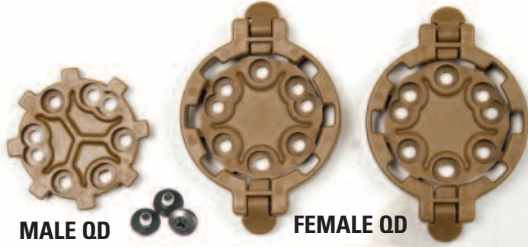

MALE QD

FEMALE QD

AVAILABLE IN BLACK, COYOTE TAN, FOLIAGE GREEN AND OLIVE DRAB

SERPA QUICK DISCONNECT SYSTEM KIT - BK, CT, FG, OD 430950 **\$41.99**

KIT COMES WITH 2 FEMALE AND 1 MALE HOLSTER ADAPTER

SERPA QD MALE ADAPTER WITH SCREWS - BK, CT, FG, OD 430951 **\$9.99**

SERPA QD FEMALE ADAPTER WITH SCREWS - BK, CT, FG, OD 430952 **\$18.99**



INSERT MALE QD INTO FEMALE QD ROTATE AND IT SNAPS INTO PLACE



TACTICAL PLATFORM



S.T.R.I.K.E. PLATFORM



SHOULDER HARNESS



CONCEALMENT BELT LOOP



FEMALE QD



MOD-U-LOK



DUTY JACKET SLOT



DUTY HIGH RIDE



CONCEALMENT PLATFORM

LEATHER CONCEALMENT HOLSTERS

-MODEL	COLOR	PART#	SIZE
Beretta 92/96	BLACK	420000BK-L or R	00
1911 5" Gov't	BLACK	420001BK-L or R	01
1911 5" Gov't	BROWN	420001BN-L or R	01 NEW!
1911 4" Comm.	BLACK	420002BK-L or R	02
Glock 17/22/31	BLACK	420003BK-L or R	03
Glock 17/22/31	BROWN	420003BN-L or R	03 NEW!
Glock 19/23/32/36	BLACK	420004BK-L or R	04
Glock 19/23/32/36	BROWN	420004BN-L or R	04 NEW!
Glock 26/27/33	BLACK	420005BK-L or R	05
Glock 26/27/33	BROWN	420005BN-L or R	05 NEW!
Glock 20/21	BLACK	420006BK-L or R	06
H&K P2000/USP Comp.	BLACK	420007BK-L or R	07
Ruger P85/89/90/91/94	BLACK	420008BK-L or R	08
S&W J Frames	BLACK	420009BK-L or R	09
S&W 4" K & L Frames	BLACK	420010BK-L or R	10
S&W most 5900/4000/900	BLACK	420011BK-L or R	11
SigPro 2009/2340/2022	BLACK	420012BK-L or R	12
Sig 228/229/225	BLACK	420013BK-L or R	13
Sig 220/226	BLACK	420014BK-L or R	14
Sig 220/226	BROWN	420014BN-L or R	14 NEW!
Springfield XD	BLACK	420015BK-L or R	15
Springfield XD	BROWN	420015BN-L or R	15 NEW!
Springfield XD Comp.	BLACK	420016BK-L or R	16
Springfield XD Comp.	BROWN	420016BN-L or R	16 NEW!
Walther P99	BLACK	420017BK-L or R	17
S&W MP 9/40 4"	BLACK	420018BK-L or R	18 NEW!
S&W MP 9/40 4"	BROWN	420018BN-L or R	18 NEW!
S&W MP 9/40 COMPACT	BLACK	420019BK-L or R	19 NEW!
S&W MP 9/40 COMPACT	BROWN	420019BN-L or R	19 NEW!
S&W MP .45 and 9/40 Pro	BLACK	420020BK-L or R	20 NEW!
SPRINGFIELD XDM	BLACK	420021BK-L or R	21 NEW!
SPRINGFIELD XDM	BROWN	420021BN-L or R	21 NEW!
BERETTA STORM PX-4	BLACK	420022BK-L or R	22 NEW!
KAHR CW9/CW40/P9/P40 (K9/K40) BLACK	BLACK	420023BK-L or R	23 NEW!

\$62.99



NEW MODELS AND COLORS!

3 SLOT LEATHER PANCAKE HOLSTER

This proven design is adaptable, comfortable and contours to your body for excellent concealment. Our reinforced thumb break allows a quick break with minimal motion. The two-piece, contour stitch design is optimized for concealment and durability. The molded design of this premium leather holster is made to curve to your waist structure and the belt slots pull the holster tight to the body for increased concealment.

- Reinforced thumb break for durability and ease of draw
- Covered trigger guard for safety and security, yet cut for a full grip at time of draw
- 3-Slot design allows for strong-side hip carry, as well as appendix carry and cross-draw options
- Contoured molding and double-stitching for a perfect fit



DETACHABLE SLIDE HOLSTER

This update to the well-known slide design allows you to attach and detach the holster to your belt in just seconds. Our belt loops go under your belt and fasten with extra strength snaps to secure the holster at your side, without ever undoing your belt. Ideal for detectives and others who are in and out of the office or regularly visit facilities where weapons have to be removed. Covered trigger guard allows high level of safety and the adjustable thumb break gives you a perfect fit for whatever model pistol you carry.

- Increased-strength snaps stay fastened
- Belt loops have angled cut for use with a variety of belt widths
- On or off in just seconds
- Black, non-reflective snap covers

MODEL	PART#	SIZE
Beretta 92/96	420100BK-L or R	00
1911 Gov't/Comm	420101BK-L or R	01
Glock 9mm/.40 cal	420102BK-L or R	02
Glock 20/21	420103BK-L or R	03
H&K P2000/USP Comp.	420104BK-L or R	04
S&W J Frames	420105BK-L	05
SigPro 2009/2340/2022	420106BK-L or R	06

MODEL	PART#	SIZE
Sig 220/225/226	420107BK-L or R	07
Springfield XD/XD Comp.	420108BK-L or R	08
Walther P99	420109BK-L or R	09
Beretta Storm PX-4	420122BK-L or R	22 NEW!
Kahr CW9/CW40/P9/P40 (K9/K40)	420123BK-L or R	23 NEW!
S&W MP all models	420128BK-L or R	28 NEW!

\$75.99

INSIDE-THE-PANTS W/CLIP HOLSTER

For the closest in concealment this holster gives you the deep concealment of inside the pants with a high inner body to protect your shirt or skin from the sharp edges and also to keep the finish of your pistol protected from moisture.

MODEL	COLOR	PART#
1911 Gov't 5"	Brown	421401BN-L or R NEW!
1911 Comm 4"	Brown	421402BN-L or R NEW!
Glock 17/19/22/23/31/32/36	Brown	421403BN-L or R NEW!
Glock 26/27/33	Brown	421404BN-L or R NEW!
SW J-Frame	Brown	421406BN-L or R NEW!
Springfield XD/XDM	Brown	421411BN-L or R NEW!
Springfield XD/XD Comp	Brown	421412BN-L or R NEW!
Kahr CW9/CW40/P9/P40/K9/K40	Brown	421423BN-L or R NEW!
\$58.99		



SLIDE W/THUMB BREAK HOLSTER

This compact leather belt slide gives you a minimalist profile with the security of a thumb break. Dual belt slots hold the pistol close to your body for excellent concealment. The open bottom design makes it an excellent choice for those who use different length models of the same handgun.

MODEL	COLOR	PART#
1911 Gov't/Comm	Brown	421101BN-L or R NEW!
Glock 9mm/.40 cal/.357/Model 36	Brown	421102BN-L or R NEW!
Glock 20/21/29/30/37/38/39	Brown	421103BN-L or R NEW!
Sig 220/225/226	Brown	421107BN-L or R NEW!
Springfield XDM/XD/XD Comp	Brown	421108BN-L or R NEW!
S&W MP all models	Brown	421128BN-L or R NEW!
\$54.99		



MULTI-POSITION HOLSTER

This classic belt scabbard allows you to wear the handgun either strong side or cross draw. It's an outstanding field holster for your large frame revolver.

MODEL	COLOR	PART#
1911 Gov't 5" Barrel	Brown	421201BN-L or R NEW!
S&W K/L Frame 4" Barrel, Ruger GP-100, All 4" Barrel, Colt King Cobra & Python	Brown	421202BN-L or R NEW!
S&W N-Frame Full Lug 4" Barrel, Ruger Redhawk 4" Barrel	Brown	421203BN-L or R NEW!
S&W N-Frame Full Lug 6" Barrel	Brown	421204BN-L or R NEW!
Ruger Super Redhawk 7.5" Barrel	Brown	421207BN-L or R NEW!
\$82.99		



TUCKABLE HOLSTER

Completely conceal your pistol without having to wear a cover garment or an untucked shirt. This tuckable holster allows you to carry your pistol and still tuck in your shirt. The clever belt clip goes under your tucked shirt and the belt attachment is so unobtrusive most people won't even see it. Rough-side out material provides a non-slip fit.

MODEL	COLOR	PART#	
2" 5 Shot Revolver	Brown	421601BN-L or R	NEW!
1911 Officer's	Brown	421602BN-L or R	NEW!
Glock 26/27	Brown	421603BN-L or R	NEW!
Glock 19/23/32/36	Brown	421604BN-L or R	NEW!
Kel-Tec/Kahr/Ruger 380's	Brown	421605BN-L or R	NEW!
Kahr CW9/CW40/P9/P40/K9/K40	Brown	421606BN-L or R	NEW!
			\$36.99

YAQUI SLIDE HOLSTER

This traditional yaqui slide design gives you the least amount of holster for a light comfortable carry. The adjustable tension screw means you can determine the ease of draw depending on your personal preference. The open bottom design is ideal for those who carry various lengths of the same model handgun.

MODEL	COLOR	PART#	
Glock 9mm/.40 cal/357/Model 36	Brown	421501BN-L or R	NEW!
Glock 20/21/29/30/37/38/39	Brown	421502BN-L or R	NEW!
1911 all lengths and clones	Brown	421503BN-L or R	NEW!
Springfield XD/XDM	Brown	421504BN-L or R	NEW!
Sig 220/225/226/228/229	Brown	421505BN-L or R	NEW!
			\$52.99

HIP SCABBARD HOLSTER

This traditional hip scabbard with thumb break gives you a low ride holster for comfort with the classic thumb break for peace of mind whether in the field, on the range or on the hunt.

MODEL	COLOR	PART#	
S&W K/L Frame 4" Barrel, Ruger GP-100 4" Barrel,			
Colt King Cobra or Python 4" Barrel	Brown	421702BN-L or R	NEW!
S&W N-Frame Full Lug 4" Barrel,			
Ruger Redhawk 4" Barrel	Brown	421703BN-L or R	NEW!
			\$62.99

CUTAWAY HOLSTER

This holster combines the security of a thumb break with the rapid draw that the cut down front of the holster body allows. Speed and security all in one package. The widely separated belt slots provide a close fit with a minimum of printing.

MODEL	COLOR	PART#	
Glock 17/22/31	Brown	421301BN-L or R	NEW!
Glock 19/23/32/36	Brown	421302BN-L or R	NEW!
Glock 26/27/33	Brown	421303BN-L or R	NEW!
1911 Gov't Model	Brown	421304BN-L or R	NEW!
1911 Commander Model	Brown	421305BN-L or R	NEW!
1911 Officer's Model	Brown	421306BN-L or R	NEW!
Springfield XD 4"/XDM	Brown	421307BN-L or R	NEW!
			\$66.99



BELT CLIP GOES UNDER YOUR TUCKED SHIRT.



COMPACT SLIDE HOLSTER WITH MAG POUCH

This holster is no bigger than most slide designs, yet offers the ability to carry a spare mag, as well. Our flex-design hugs the waistline and offers a compact, complete package. Open bottom allows use of different slide lengths and increases versatility. Holster is cut to allow a full combat grip, yet covers trigger guard for added safety. Holster is cut to allow a full combat grip, yet covers trigger guard for added safety. Rear belt loop works with unique dual front belt loop design to allow use as strong side or appendix carry. Some may even find it suitable as a cross-draw.



- Available for single-stack and double-stack model pistols
- Molded detent helps keep magazine in place and mag position won't interfere with draw or re-holster
- Unique dual front belt loop allows multiple carry modes
- Adjustable tension screws



VERTICAL CANT



BUTT FORWARD

MODEL	PART#	SIZE
Beretta 92/96	420200BK-L or R	00
1911 Gov't/Comm.	420201BK-L or R	01
Glock 17/19/22/23	420202BK-L or R	02
Glock 26/27/33	420203BK-L or R	03
H&K P2000/USP Comp.	420204BK-L or R	04
SigPro 2009/2340/2022	420205BK-L or R	05
Sig 228/229/226	420206BK-L	06
Springfield XD/XD Comp.	420208BK-L or R	08
Walther P99	420209BK-L or R	09
Beretta Storm PX-4	420222BK-L or R	22 NEW!
Kahr CW9/CW40/P9/P40 (K9/K40)	420223BK-L or R	23 NEW!
S&W MP 9mm./ .40 cal./ .357 Sig - all models	420228BK-L or R	28 NEW!

\$66.99

LEATHER CHECK-SIX™ HOLSTER

Whether behind the back or just behind the hip, this holster gives you options, comfort and speed. Contour double-stitched premium leather has a molded sight track, adjustable tension screw and dual belt slots designed to pull the gun tight to your body. Cut to provide a combat grip from the start, this holster gives you outstanding concealability, even when your covering garment is open. When employing a long gun as primary weapon, this holster's position is perfect for your handgun, as it won't interfere with operation of the long gun.

- Designed to hold handgun close to the natural contour of the waist
- Ideal for secondary weapons
- Flat holster back keeps sharp edges away from body
- Low profile design aids concealment

MODEL	COLOR	PART#	SIZE
Beretta 92/96	Black	420700BK-L or R	00
1911 Gov't 5"	Black	420701BK-L or R	01
1911 Comm. 4"	Black	420702BK-L or R	02
Glock 17/19/22/23	Black	420703BK-L or R	03
Glock 26/27/33	Black	420704BK-L or R	04
S&W J Frame	Black	420705BK-L or R	05
SigPro 2009/2340/2022	Black	420706BK-L or R	06
Sig 228/229/225	Black	420707BK-L or R	07
Springfield XD Comp.	Black	420708BK-L or R	08
Walther P99	Black	420709BK-L or R	09
S&W MP 9/40 4"	Black	420718BK-L or R	18 NEW!
S&W MP 9/40 Compact	Black	420719BK-L or R	19 NEW!
S&W MP .45 and Pro 9/40	Black	420720BL-L or R	20 NEW!
Springfield XD/XDM	Black	420721BK-L or R	21 NEW!
Beretta Storm PX-4	Black	420722BK-L or R	22 NEW!
Kahr CW9/CW40/P9/P40 (K9/K40)	Black	420723BK-L or R	23 NEW!

\$63.99



PASSIVE RETENTION ADJUSTMENT SCREW

LEATHER INSIDE-THE-PANTS HOLSTER

For deep concealment for a secondary weapon, working undercover or just off-duty, this is the ideal choice. Features a shirt shield to keep leather between the slide and your body to increase comfort and prevent shirt from blocking holster. Angle-adjustable belt loop is mounted to reinforced upper body for stability.

- Adjustable tension-screw gives you the choice on level of retention
- Shirt shield protects clothing, keeps holster opening unobstructed and increases comfort
- Allows use for middle-of-the-back, strong side, appendix or cross-draw carry
- Less bulk than most leather inside-the-pants holsters
- Molded sight track for smooth draw and re-holster



PASSIVE
RETENTION
ADJUSTMENT
SCREW

MODEL	PART#	SIZE
Beretta 92/96	420400BK-L or R	00
1911 Gov't 5"	420401BK-L or R	01
1911 Comm. 4"	420402BK-L or R	02
Glock 17/19/22/23/31	420403BK-L or R	03
Glock 26/27/33	420404BK-L or R	04
H&K P2000/USP Comp.	420405BK-L or R	05
S&W J Frame	420406BK-L or R	06
S&W most 5900/4000/900	420407BK-L or R	07
SigPro 2009/2340/2022	420408BK-L	08
Sig 228/229/225	420409BK-L or R	09
Sig 220/226	420410BK-L or R	10
Springfield XD	420411BK-L or R	11
Springfield XD Comp.	420412BK-L or R	12
Walther P99	420413BK-L	13
S&W MP 9/40 4"	420418BK-L or R	18 NEW!
S&W MP 9/40 Compact	420419BK-L or R	19 NEW!
S&W MP .45 and 9/40 Pro	420420BK-L or R	20 NEW!
Springfield XDM	420421BK-L or R	21 NEW!
Beretta Storm PX-4	420422BK-L or R	22 NEW!
Kahr CW9/CW40/P9/P40 (K9/K40)	420423BK-L or R	23 NEW!

\$63.99

LEATHER COMPACT ASKINS

This venerable design has been updated with the highest quality leather and a minimalist approach that allows more versatility and comfort than before. The belt loop sewn to the back of the holster keeps the handgun close to the waist and the trailing belt slot pulls the butt into the body for greater concealment. Reinforced holster mouth assures easy re-holstering and the adjustable tension screw lets you choose the ease of draw for your handgun. Our injection-molded sight track allows the use of even high custom sights and keeps them from dragging on the holster.

- Trailing belt slot pulls grip in, greatly increasing concealment
- Adjustable tension screw allows fine-tuning for personal preference
- Reinforced opening allows consistent ease in re-holstering
- Use full-size or compact model handguns

MODEL	COLOR	PART#	SIZE
Beretta 92/96	Black	420500BK- L	00
1911 Gov't/Comm	Black	420501BK- L or R	01 NEW!
1911 Gov't/Comm	Brown	420501BN- L or R	01 NEW!
Glock 17/19/22/23/26	Black	420502BK- L or R	02
Glock 9mm/.40 cal./357/ Model 36	Brown	420502BN-L or R	02 NEW!
Glock 20/21	Black	420503BK- L or R	03
Glock 20/21/29/30/37/38/39	Brown	420503BN-L or R	03 NEW!
H&K P2000/USP Comp.	Black	420504BK- L or R	04
Ruger P85/89/90/91/94	Black	420505BK- L	05
S&W J Frame	Black	420506BK- L or R	06
S&W 4" K/L Frame	Black	420507BK- L or R	07
S&W most 5900/4000/900	Black	420508BK- L	08
SigPro 2009/2340/2022	Black	420509BK- L or R	09
Sig 220/225/226	Black	420510BK- L or R	10
Springfield XD/XD Comp./XDM	Black	420511BK- L or R	11
Springfield XD/XD Comp./XDM	Brown	420511BN- L or R	11 NEW!
Walther P99	Black	420512BK- L or R	12
Beretta Storm PX-4	Black	420522BK-L or R	22 NEW!
Kahr CW9/CW40/P9/P40 (K9/K40)	Black	420223BK-L or R	23 NEW!
S&W MP all models	Black	420528BK-L or R	28 NEW!
S&W MP all models	Brown	420528BN-L or R	28 NEW!

\$61.99



PASSIVE
RETENTION
ADJUSTMENT
SCREW

ANGLE-ADJUSTABLE PADDLE HOLSTER

Our paddle holster gives you a flat profile for maximum concealment, with a paddle design that takes your comfort very seriously. Even though the holster is constructed for minimal bulk, it still features a sewn in sight track, wrap around trigger guard cover and a reinforced thumb break for a rapid draw and easy re-holstering.

Easy on the angle adjustable paddle stays where you want it, but allows you to remove the holster without undoing your pants. This holster is an excellent choice for those who have to remove and replace weapon throughout the day in office or secured facilities. Holster design covers trigger guard, yet is cut to allow a full grip before draw.

- Wrap around trigger guard keeps slick-slide pistols from rocking out from under retention strap
- Sewn in sight track for smooth draw - no worries about custom sights snagging in holster
- Flat profile hugs body for maximum concealment
- Molded, angle adjustable polymer paddle designed for comfort and stability



MODEL	COLOR	PART#	SIZE
Beretta 92/96	Black	420600BK-L or R	00
1911 Gov't 5 "	Black	420601BK-L or R	01
1911 Gov't 5 "	Brown	420601BN-L or R	01 NEW!
Colt Comm. 4"	Black	420602BK-L or R	02
Colt Comm. 4"	Brown	420602BN-L or R	02 NEW!
Glock 17/22/31	Black	420603BK-L or R	03
Glock 17/22/31	Brown	420603BN-L or R	03 NEW!
Glock 19/23/32/36	Black	420604BK-L or R	04
Glock 19/23/32/36	Brown	420604BN-L or R	04 NEW!
Glock 20/21	Black	420606BK-L	06
H&K P2000/USP Comp.	Black	420607BK-L or R	07
Ruger P85/89/90/91/94	Black	420608BK-L	08
S&W J Frame	Black	420609BK-L or R	09
S&W most 5900/4000/900	Black	420610BK-L or R	10
SigPro 2009/2340/2022	Black	420611BK-L or R	11
Sig 228/229/225	Black	420612BK-L	12
Sig 220/226	Black	420613BK-L or R	13
Springfield XD	Black	420614BK-L or R	14
Springfield XD	Brown	420614BN-L or R	14 NEW!
Springfield XD Comp.	Black	420615BK-L or R	15
Walther P99	Black	420616BK-L or R	16

\$85.99

LEATHER SPEED CLASSIC (AVAILABLE FOR MOST 2" AND 2 1/8 S&W, RUGER, TAURUS AND OTHER FIVE SHOT REVOLVERS)

The ultimate in speed for the ultimate in hideout handguns. This adaptation of the famous Berns-Martin design gives you a quick draw with secure carry and goes back to what the original models were, a small holster for a small handgun. This is not the big, bulky version some did later, which ignored the intent of a thin, minimalist design. The holster is handmade of premium, wet-molded leather and heavy duty elastic for a secure fit and a trailing edge belt loop, to pull the grip in tight to the body. Under a T-shirt, sweatshirt or suit coat, this will hold your snub-nose the way it was meant to be.



MODEL	COLOR	PART#	SIZE
J-Frame/Taurus 85/SP-101	Black	420800BK- L or R	00
J-Frame/Taurus 85/SP-101	Brown	420800BN-L or R	00 NEW!

\$44.99



NYLON HOLSTERS



SCOPED PISTOL BANDOLIER HOLSTERS

- Ideal for carrying large scoped hunting or target guns across your chest or back
- Adjustable padded shoulder strap and belt loop
- Removable, adjustable padded flap protects gun in all weather retention strap included for use when flap is removed

MODEL SIZE-	COLOR-MOSSY OAK BREAK UP	PART#	SIZE
Scoped 5" - 6 1/2" barrel medium & large double action revolvers & 4 5/8" - 5 1/2" barrels single action revolvers-Mossy Oak Break Up		40SB03M1-R	03
Scope 7" - 8 1/2" barrel medium & large double action revolvers, 6"-7 1/2" barrel single action revolvers, & 10" barrel Thompson/Center Contenders- Mossy Oak Break up		40SB04M1-R	04
Scoped 14" - 16" barrel Thompson/Center Super Contenders Encore, 10" barrel Remington XP-100, 9 1/2" - 10 1/2" barrel Single/double action revolvers, Savage Striker, Ruger Charger - Mossy Oak Break up		40SB13M1-R	13
MODEL SIZE-	COLOR-BLACK	PART#	SIZE
Scoped 5" - 6 1/2" barrel medium & large double action revolvers & 4 5/8" - 5 1/2" barrels single action revolvers-Black		40SB03BK-R	03
Scope 7" - 8 1/2" barrel medium & large double action revolvers, 6"-7 1/2" barrel single action revolvers, & 10" barrel Thompson/Center Contenders- Black		40SB04BK-R	04
Scoped 14" - 16" barrel Thompson/Center Super Contender, Encore; 10" barrel Remington XP-100; 9 12" - 10 3/4" barrel single/double action revolvers; Savage Striker; Ruger Charger		40SB13BK-R	13
			\$63.50



HIP HOLSTERS WITH THUMB BREAK

- Dual slot belt loops so that it may be used on duty, sport or dress belts
- Laminate construction makes holster waterproof and protective
- Molded thumb break and non-stretch retention strap assure safety

MODEL SIZE	PART#	SIZE
2"-3" Barrel small/medium double action revolvers • except 2" 5-shot	40HT00BK-R or L	00
3" - 4" Barrel medium frame 32/380 autos	40HT01BK-R or L	01
4" Barrel medium & intermediate double action revolvers	40HT02BK-R or L	02
6" Barrel medium & intermediate double action revolvers	40HT03BK-R or L	03
4 1/2" - 5" Barrel large autos	40HT05BK-R or L	05
3 3/4"-4 1/2" Barrel large autos	40HT15BK-R or L	15
3 1/4" - 3 3/4" Barrel medium & large autos	40HT16BK-R or L	16
Colt Gov't large autos, Browning Hi-Power	40HT19BK-R or L	19
Glock 17, 19, 20, 21, 22, 23, 29, 36	40HT21BK-R or L	21
2" barrel small frame 5-shot revolvers with hammer spur	40HT36BK-R or L	36
		\$25.15



VERTICAL SHOULDER HOLSTERS

- Vertical carry provides excellent concealment, comfort and retention
- Offside tie-down has dual picatinny rail platform for accessories
- Cordura® nylon outer shell and waterproof closed-cell foam padding provides moisture barrier
- Non-stretch finger break and retention straps are adjustable for various size pistols

MODEL SIZE	COLOR	PART#	SIZE
2" - 3" Barrel small & medium double action revolvers	Black	40VH00BK-R or L	00
3" - 4" Barrel medium autos & 3 1/4 - 3 3/4 barrel large autos	Black	40VH01BK-R or L	01
3" - 4" Barrel medium & large double action revolvers	Black	40VH02BK-R or L	02
5" - 6 1/2" Barrel medium & large double action revolvers & 4 5/8" - 5 1/2" barrel single action revolvers	Black	40VH03BK-R or L	03
7" - 8 1/2" Barrel medium & large double action revolvers & 6" - 7 1/2" barrel single action revolvers	Black	40VH04BK-R or L	04
4 1/2" - 5" Barrel large autos, open end, safety strap rotates to secure autos either on grip or hammer	Black	40VH05BK-R or L	05
5 1/2" - 6" Barrel .22 autos & airguns	Black	40VH06BK-R or L	06

\$43.30

MODEL SIZE	COLOR	PART#	SIZE
9 1/2" - 10 1/2" Barrel single & double action revolvers	Black	40VH11BK-R or L	11
10" Barrel Thompson/Center Contenders	Black	40VH12BK-R or L	12
14" & 16" Barrel T/C Super Contenders, Encore & 10" barrel Remington XP-100	Black	40VH13BK-R or L	13
3 1/2" - 4 1/2" Barrel large autos	Black	40VH15BK-R or L	15

\$46.35

MODELS SIZE FOR GUNS WITH A SCOPE

MODEL SIZE	COLOR	PART#	SIZE
5" - 6 1/2" Barrel medium & large double action & 4 5/8" - 5 1/2" barrel single action revolvers	Mossy Oak Break up	40SV03M1-R	03
5" - 6 1/2" Barrel medium & large double action & 4 5/8" - 5 1/2" barrel single action revolvers	Black	40SV03BK-R or L	03
7" - 8 1/2" Barrel medium & large double action & 6" - 7 1/2" barrel single action revolvers, & 10" barrel T/C Contenders	Mossy Oak Break up	40SV04M1-R	04
7" - 8 1/2" Barrel medium & large double action & 6" - 7 1/2" barrel single action revolvers, & 10" barrel T/C Contenders	Black	40SV04BK-R or L	04
14" & 16" Barrel T/C Super Contenders, Encore & 10v barrel Remington XP-100, & 9 1/2" - 10 1/2" Barrel single & double action revolvers	Mossy Oak Break up	40SV13M1-R	13
14" & 16" Barrel T/C Super Contenders, Encore & 10v barrel Remington XP-100, & 9 1/2" - 10 1/2" Barrel single & double action revolvers	Black	40SV13BK-R or L	13

\$51.35



COMPACT BELT SLIDE HOLSTERS

- Ambidextrous design
- Nylon web belt loops on both sides fit belts up to 1 1/2" wide
- Fits most autos and revolvers



MODEL SIZE	PART#	SIZE
Most autos & revolvers	40CS00BK	00
.22 and .25 autos and very small frame .380's	40CS01BK	01
\$21.10		



HORIZONTAL SHOULDER HOLSTERS

- Horizontal carry and lightweight for increased comfort
- Offside plate for optional accessories
- Molded thumb break and non-stretch retention strap

MODEL SIZE	PART#	SIZE
MEDIUM = MD, FITS M-XL SHIRT, LARGE = LG, FITS L-XXL SHIRT		
2" - 3" Barrel small/medium double action revolvers • except 2" 5-shot	40HS00BK MD or LG	00
3" - 4" Barrel medium frame 32/380 autos	40HS01BK MD or LG	01
4" Barrel & intermediate double action revolvers	40HS02BK MD or LG	02
4 1/2" - 5" Barrel large autos	40HS05BK MD or LG	05
3 3/4" - 4 1/2" Barrel large autos	40HS15BK MD or LG	15
3 1/4" - 3 3/4" Barrel medium and large autos	40HS16BK MD or LG	16
2" Barrel small frame 5-shot revolvers with hammer spur	40HS36BK MD or LG	36
\$56.40		



PADDLE HOLSTERS

- Paddle adjusts for vertical, butt-forward or muzzle-forward carry
- Holster encloses trigger guard and features a non-stretch retention strap and molded thumb break



MODEL SIZE	PART#	SIZE
2" - 3" Barrel small/medium double action revolvers • except 2" 5-shot	40PH00BK-R	00
3" - 4" Barrel medium frame 32/380 autos	40PH01BK-R	01
4" Barrel & intermediate double action revolvers	40PH02BK-R	02
4 1/2" - 5" Barrel large autos	40PH05BK-R	05
3 3/4" - 4 1/2" Barrel large autos	40PH15BK-R	15
3 1/4" - 3 3/4" Barrel medium & large autos	40PH16BR-R	16
Colt Gov't large autos, Browning Hi-Power	40PH19BK-R	19
Glock 17, 19, 20, 21, 22, 23, 29, 30	40PH21BK-R	21
2" Barrel small frame 5-shot revolvers with hammer spur	40PH36BK-R	36
\$41.25		



ANGLE DRAW SHOULDER HOLSTER

- Comfortable concealment on or off duty; fully adjustable harness system
- Quick and efficient draw with a 45° set angle
- Twin spare mag carriers provide extra ammo storage and balance
- Dual retention thumb snap and adjustable belt attachment strap
- Fully ambidextrous
- One size fits most small, medium and large frame weapons

PART#	SIZE
40SH00BK	00
\$61.99	



SHOULDER HOLSTER - CONCEALED

- Thumb break is fully adjustable; holster fits most standard autos
- Talon-Flex™ insert stiffens the holster for quick efficient draw and reholstering
- Comes with double mag pouch, shoulder harness, holster and belt securing attachments
- Fully ambidextrous

NSN#	PART#	SIZE
<i>NSN# 8465-01-520-7278</i>	40SH02BK	02
	\$69.99	



UNIVERSAL SPEC-OPS PISTOL HARNESS

- Can be worn cross-body in multiple positions: vertical, horizontal, or angled
- Padded and fully adjustable
- Fits most auto pistols
- Right hand only

PART#	SIZE
40SH04BK	04
\$67.99	



BLACKHAWK!® M-26 TASER® HOLSTER

- Can be worn as a drop-leg or high-rise duty holster
- Quick release buckle for rapid on/off capability
- Standard thumb break with extra retention strap
- 2 cartridge pouches on front of holster
- Non-slip leg strap

PART#	SIZE
40TA00BK	00
\$79.99	



X26 TASER® HOLSTER-BLACK

- Ambidextrous belt mount or drop-leg configuration
- For drop-leg: 56DLE1 or 56DLE2 extender / 40LS02 or 40LS03 adjustable leg straps
- Flap secures with side release buckle; also has hook & loop for quick re-holstering
- Flap can also be folded over and secured out of the way
- Adjustable internal strap and external loop of elastic for additional retention

PART#	SIZE
40TA02BK	02
\$29.99	



M-26 TASER® UNIVERSAL HARNESS/HOLSTER

- Two extra cartridge pouches
- Adjustable for underarm or chest carry
- Security strap

PART#	SIZE
40SH05BK	05
\$67.99	

NEW! BLACKHAWK!® C-2 TASER® HOLSTER

- Made of 1/8" cordura padded laminate
- Fits C2 Civilian Taser
- Thumb Break style retention strap with snap
- Molded Belt loop
- Weight: 1.6oz

40C200BK	\$24.99
----------	----------------



3-SLOT PANCAKE HOLSTER [AMBIDEXTROUS]

- Ambidextrous (adjustable retention strap and thumb break are reversible)
- 3-slot design allows strong side, kidney, or cross-draw mount options
- Belt slots pull the holster body close for better concealment
- Fits belts up to 1 3/4 inches wide
- Lined with a smooth, snag-resistant material



MODEL SIZE	PART#	SIZE
2" - 3" Barrel small/medium double action revolvers-except 2" 5-shot	40PC00BK	00
3" - 4" medium autos frame 32/380 autos	40PC01BK	01
4" Barrel medium and intermediate double action revolvers	40PC02BK	02
4 1/2" - 5" Barrel large autos	40PC03BK	03
Glock 26, 27, 33 & other sub-compact 9mm/.40cal.	40PC04BK	04
3 3/4" - 4 1/2" Barrel large autos	40PC05BK	05
3 1/4" - 3 3/4" Barrel medium & large autos	40PC06BK	06
Colt Gov't large autos, Browning Hi-Power	40PC07BK	07
HK USP 9mm, .40, .45, USP Compact	40PC30BK	30
2" Barrel small frame 5-shot revolvers with hammer spur	40PC36BK	36
	\$27.20	

HIP HOLSTERS



- Internal moisture barrier won't transmit perspiration to gun
- Smooth nylon lining for easy draw
- Adjustable retention strap with non-glare snaps



MODEL SIZE	PART#	SIZE
2" - 3" Barrel small/medium double action revolvers except 2" 5-shot	73NH00BK-R or L	00
3" - 4" Barrel medium 32/380 frame 32/380 autos	73NH01BK-R or L	01
3" - 4" Barrel medium & large double action revolvers	73NH02BK-R or L	02
5" - 6 1/2" Barrel medium & large double action revolvers	73NH03BK-R or L	03
4 1/2" - 5" Barrel large autos, open end	73NH04BK-R or L	04
Small autos (.22-.25 cal.) and very small frame 380's	73NH05BK-R or L	05
Glock 26, 27 and other subcompact 9/40	73NH06BK-R or L	06
3 1/2" - 4 1/2" Barrel large autos, open end	73NH07BK-R or L	07
3 1/4" - 3 3/4" Barrel medium & large autos	73NH08BK-R or L	08
2" small frame 5-shot revolvers with hammer spur	73NH09BK-R or L	09
7" - 8 1/2" Barrel medium & large double action revolvers, tie-down loop included	73NH10BK-R or L	10
9 1/2" - 10 1/2" Barrel single & double action revolvers, tie-down loop included	73NH11BK-R or L	11
3 1/2" - 5" Barrel single action revolvers	73NH12BK-R or L	12
5 1/2" - 6 1/2" Barrel single action revolvers	73NH13BK-R or L	13
6 7/8" Barrel .22 autos	73NH14BK-R or L	14
6 1/2" - 7 1/2" Barrel single action revolvers	73NH15BK-R or L	15
5 1/2" - 6" Barrel .22 autos and airguns	73NH16BK-R or L	16
10 1/2" Barrel .22 autos, tie-down loop included	73NH17BK-R or L	17
6" Raging Bull, 6" S&W N-Frame full lug	73NH18BK-R or L	18
8 3/8" Raging Bull, 8 3/8" S&W N-Frame full lug	73NH19BK-R or L	19
	\$17.65	



INSIDE-THE-PANT HOLSTERS WITH RETENTION STRAP

- Ultra-thin four layer laminate provides moisture barrier to protect weapon
- Smooth nylon lining for easy draw
- Fold-over Hook & Loop retention strap
- Belt clip slips over pant top or belt to retain holster

MODEL SIZE	PART#	SIZE
2" - 3" Barrel small/medium double action revolvers • except 2" 5-shot	73IR00BK-R or L	00
3" - 4" Barrel medium frame 32/380 autos	73IR01BK-R or L	01
4" Barrel medium and intermediate double action revolvers	73IR02BK-R or L	02
4 1/2" - 5" Barrel large autos	73IR03BK-R or L	03
Small autos (.22-.25 cal.) and very small frame 380's	73IR04BK-R or L	04
3 3/4" - 4 1/2" Barrel large autos	73IR06BK-R or L	06
3 1/4" - 3 3/4" Barrel medium and large autos	73IR07BK-R or L	07
2" Barrel small frame 5-shot revolvers with hammer spur	73IR08BK-R or L	08

\$18.65



INSIDE-THE-PANT HOLSTERS

- Ultra-thin four layer laminate provides moisture barrier to protect weapon
- Internal moisture barrier won't transmit perspiration to firearm
- Smooth nylon for easy draw
- Belt clips slips over pant top or belt to retain holster



MODEL SIZE	PART#	SIZE
2" - 3" Barrel small/medium double action revolvers • except 2" 5-shot	73IP00BK-R or L	00
3" - 4" Barrel medium frame 32/380 autos	73IP01BK-R or L	01
4" Barrel medium and intermediate double action revolvers	73IP02BK-R or L	02
4 1/2" - 5" Barrel large autos	73IP03BK-R or L	03
Small autos (.22-.25 cal.) and very small frame 380's	73IP04BK-R or L	04
Glock 26, 27, 33 & other sub-compact 9mm/.40cal.	73IP05BK-R or L	05
3 3/4" - 4 1/2" Barrel large autos	73IP06BK-R or L	06
3 1/4" - 3 3/4" Barrel medium & large autos	73IP07BK-R or L	07
2" Barrel small frame 5-shot revolvers	73IP08BK-R or L	08

\$12.60



AMBIDEXTRIOUS MULTI-USE HOLSTER WITH MAGAZINE POUCH

- Ambidextrous belt or inside-the-pants
- Spring steel removable clip
- Belt loops act as covers for a reversible retention strap and thumb break
- Fits belts up to 1 3/4 inches in a traditional vertical position, or:
- Fits belts up to 1 1/2 inches when worn horizontally as a middle-of-the-back holster
- Spare magazine pouch with adjustable flap on front of holster
- Non stretch hook and loop retention strap and molded thumb break

MODEL SIZE	PART#	SIZE
3" - 4" BARREL MEDIUM AND LARGE DOUBLE ACTION REVOLVER	40AM02BK	02
UP TO 2 1/4" SMALL FRAME 5 AND 6-SHOT REVOLVERS WITH HAMMER SPUR	40AM36BK	36
3" - 4" BARREL MEDIUM FRAME 32/380 AUTOS	40AM01BK	01
4 1/2" - 5" BARREL LARGE AUTOS	40AM03BK	03
3 3/4" - 4 1/2" BARREL LARGE AUTOS	40AM05BK	05
3 1/4" - 3 3/4" BARREL MEDIUM AND LARGE AUTOS	40AM06BK	06
	\$29.20	



ANKLE HOLSTERS-BLACK

- Comfortable enough to wear against skin due to soft knit fabric
- Closed cell foam acts as a moisture barrier and provides padding for comfort
- Molded thumb break and non-stretch retention strap.

MODEL	PART#	SIZE
2" BARREL SMALL FRAME 5-SHOT REVOLVERS W/ HAMMER SPUR	40AH00BK-R or L	00
3" - 4" BARREL MEDIUM FRAME AUTOS (.32-.380 CAL.)	40AH01BK-R or L	01
SMALL AUTOS (.22-.25 CAL.)AND 380'S	40AH10BK-R or L	10
GLOCK 26, 27, 33 & OTHER SUB-COMPACT 9MM/.40 CAL	40AH12BK-R or L	12
3 1/4" - 3 3/4" BARREL MEDIUM AND LARGE AUTOS	40AH16BK-R or L	16
	\$39.30	



INSIDE-THE-POCKET HOLSTERS

- Laminate construction lessens outline of gun, cushions wearer's leg from sharp contours of the firearm, and provides a barrier against perspiration
- Open-top holster provides grip-up positioning and protects the weapon in the pocket
- Non-slip material band surrounds holster body to retain holster in pocket when firearm is drawn

MODEL	PART#	SIZE
SMALL AUTOS (.22-.25 CAL.)	40PP01BK	01
MOST .380'S	40PP02BK	02
2" 5-SHOT REVOLVERS, RUGER/KEL-TEC .380S	40PP03BK	03
MOST SUB-COMPACT 9MM/.40 AUTOS	40PP04BK	04
	\$12.60	





UNIVERSAL FIT HOLSTER-BLACK

- Wrap-around holster with “hook” backing attaches to any “loop” material
- Mounts in our Battle Bag, Executive Attaché Case, Patrolman’s Modular Gear Bag, Enhanced Modular Insert/Range Bag, Homeland Security Discreet Case, Discrete SOCOM Pistol Case, and Urban Carry Case

60WFOHBK \$10.99



AMBIDEXTROUS FLAT BELT HOLSTER

- Fits any belt up to 2” and holds most small to medium frame and medium to large frame autos and revolvers
- Adjustable ambidextrous thumb break

40FB02BK BLACK \$20.99

NSN# 1095-01-520-5937



CONCEALED WEAPON FANNY PACK WITH HOLSTER AND RETENTION BELT LOOPS

- Internal fully adjustable universal holster with thumb break
- Retention belt loops attach this pack to your pants belt for extra security and retention

60WFO4BK	BLACK	SMALL
60WFO5BK	BLACK	MEDIUM
60WFO6BK	BLACK	LARGE
\$64.99		

BELT POUCH HOLSTERS

These clever concealment pouches allow you to carry “hidden in plain sight.” Designed to mimic a camera or tourist pouch, each has a top zipper opening that can remain open or closed with your handgun hidden behind a hook-and-loop flap. A separate pocket sewn to the front of the pouch carries keys, cuffs, ID or change and is an ideal spot for a camera company patch or other “corporate camouflage.” Dual belt loops fit any belt up to 2” wide.

MINI BELT POUCH HOLSTER

8” L X 5 1/2” H X 1 5/8” D
Fits 5-shot revolvers and subcompact autos

40BP00BK \$44.99

LARGE BELT POUCH HOLSTER

8 1/2” W X 7” H X 1 5/8” D
Fits full size autos up to 4-inch barrel

40BP01BK \$47.99



HIDDEN POCKET OPENS TO REVEAL HANDGUN



POUCH OPENS WHILE HANDGUN REMAINS HIDDEN



HANDGUN IS HIDDEN IN PLAIN SIGHT

OMEGA® VI ELITE HOLSTER

- Drop Leg thigh holster with quick release belt mount adjustable to any length
- Elastic rubberized leg straps for stability and comfort
- Three-point breakaway (three side-release buckles; top and two leg straps)
- Adjustable thumb break with extra hook and loop retention
- Front mounted pouch for extra magazine, knife, or light
- Additional retention strap for extreme ops (can be removed)

MODEL	PART#	SIZE
GLOCK 17/19/22/23/27/31/32	40QD02_OD, CT, BK-L or R	02
M1911 COLT 45 & BROWNING HP	40QD22_OD, BK-L or R CT-R ONLY	22
GLOCK 20, 21/USP 40,45-BLACK	40QD32BK-L or R	32
M9 (BERETTA 92F)/SW 5906	40QD42_FG, AU, DE BK-L or R	42
	\$85.99	



SPECIAL OPERATIONS HOLSTER

- Maximum weapon protection and retention with top flap over pistol
 - Belt-mounted with single stabilizing elastic/rubberized leg strap
 - Adjustable thumb break for quick draw of most large frame weapons
 - Flap is secured open by hook & loop or closed by a side release buckle
 - Front mounted pouch for extra magazine, knife, or light
 - Additional magazine pouches can be mounted horizontally on belt flap
- Part numbers for pouches 38CL06/08/09/10
- Fits most large frame weapons

PART#	SIZE	NSN#
40XP00_BK,DE, or AU-L or R	00	
40XP000D-L or R OLIVE DRAB	00	NSN# 8465-01-501-8078
	\$63.99	



OMEGA® VI ULTRA UNIVERSAL MODULAR LIGHT HOLSTER (FOR PISTOLS WITH OR WITHOUT LIGHT OR LASER AIMING MODULE)

- Can be configured for left- or right-hand shooters
- Can be removed from the drop leg harness for wear on a belt or any MOLLE platform such as a vest (includes speed clips)
- Drop Leg thigh holster with quick release belt mount adjustable to any length
- Elastic rubberized leg straps for stability and comfort
- Three-point breakaway (three side-release buckles; top and two leg straps)
- Adjustable thumb break with extra hook and loop retention
- Front mounted pouch for extra magazine, knife, or light

PART#
40MLH1_AU, OD, CT, BK
\$106.99



HOLSTER ACCESSORIES

BLACKHAWK!® CQC® CONCEALMENT MODULAR ACCESSORIES FEATURING OUR PICATINNY SYSTEM



In our Carbon-Fiber Composite line, we offer single magazine pouches for both 9mm/40 cal. single-stack mags and 9mm/40 cal. double-stack mags. These have a built-in tension spring that keeps your mag secure but allow rapid removal when you need it. We also offer two different light carriers, one for the detachable pistol lights, such as the M-3 style and one for small personal lights, like the Streamlight® and Surefire® lights.

CARBON-FIBER MAGAZINE CASES [PATENTS PENDING]

Our magazine pouches have a built-in tension spring, to hold your magazine in place until you need it and to allow the use of a variety of magazines in each pouch. The most interesting thing about our magazine pouches is that the unique belt clip can be removed and they can be placed side by side on our Dual Rail Accessory Platform, for those wanting a double magazine pouch, on the same carrier. Or, they can be placed beside one of our light carriers, for a combo light/mag carrier.



CARBON FIBER FINISH



BLACK(BK)



COYOTE TAN(CT)



OLIVE DRAB(OD)



FOLIAGE GREEN(FG)



SINGLE MAG CASE

SINGLE STACK SINGLE MAG CASE-BLACK

Single Stack Mag - Carbon Fiber Finish-9MM/.40 Cal	410500CBK	\$21.99
Single Stack Mag - Matte Finish	410500P__FG, OD, BK, CT	\$20.99

DOUBLE STACK SINGLE MAG CASE

Double Stack Single Mag - Carbon Fiber Finish-9MM/.40 Cal	410600CBK	\$21.99
Double Stack Single Mag - BK, OD, FG, CT	410600P__FG, OD, BK, CT	\$20.99

NEW!

DOUBLE MAG CASE

- Now twice the capacity of our single mag pouch with the same great tension spring for different width magazines
- Available in both single stack and staggered column magazine versions
- Includes both belt loops and belt clip
- Adjustable hook for different width belts on the belt clip
- Curved to waist line for slimmer profile

SINGLE STACK DOUBLE MAG CASE-BLACK

Single Stack Mags- Carbon Fiber Finish-9MM/.40 Cal	410510CBK	\$34.99
Single Stack Mags - Matte Finish-9MM/.40 Cal	410510PBK	\$29.99

DOUBLE STACK DOUBLE MAG CASE-BLACK

Double Stack Mags- Carbon Fiber Finish-9MM/.40 Cal	410610CBK	\$34.99
Double Stack Mags - Matte Finish-9MM/.40 Cal	410610PBK	\$29.99





CARBON-FIBER DUAL RAIL ACCESSORY PLATFORM [PATENTS PENDING]

This Dual Rail™ Accessory Platform comes with a bracket already installed on one of the rails for the M-3/M-6 family of lights and allows you to pick any of our other Belt-Clip mounted accessories and place them alongside one of these platforms. If you don't want the M-3 holder, simply remove it and mount another accessory of your choice. Available in both paddle and belt loop models, these Dual Rail Accessory Platforms are another example of how BLACKHAWK! CQC gives you choices.



DUAL RAIL™ ACCESSORY PADDLE

410800CBK *NSN# 8465-01-530-0991* **\$23.99**

DUAL RAIL™ ACCESSORY BELT LOOP

411300CBK *NSN# 8465-01-530-0990* **\$23.99**

CF DUAL RAIL™ ACCESSORY PLATFORM SHOWN WITH MAGAZINE POUCH AND M-3 LIGHT CARRIER. M-3 LIGHT CARRIER INCLUDED.

LIGHT AND MAG POUCH SOLD SEPARATELY



CARBON-FIBER M-3 LIGHT CARRIER [PATENTS PENDING]

This carrier is designed for Picatinny rail mounted weapons lights, such as the M-3 and M-6 family of lights, as well as some of the other smaller models. The belt clip allows use with any standard width pants belt.

The M-3 Carrier is designed to lock the switch in the off position, preventing it from accidentally turning on while you are wearing it. Or, you can carry the light in the lens down position and it will protect the lens from damage. The high-strength Carbon-Fiber Composite ensures years of service.



M-3 LIGHT CARRIER

411100CBK *Black*
\$15.99

LIGHT NOT INCLUDED



COMPACT LIGHT CARRIER [PATENTS PENDING]

This small yet rugged carrier is designed to carry the smaller personal-sized lights that are so popular with cops, soldiers and civilians, such as the Streamlight® Scorpion, TL-2 and TL-3. The built-in tensioning device allows the use of all these lights and keeps them in place and ready for use. The button recess at the bottom of the carrier prevents the accidental activation of light switches that protrude from the tail cap.

Our light carrier also has the same belt clip as our magazine cases and can be removed from the belt clip and used on one of the Dual Rail Accessory Platforms for a combo carrier for light and pistol magazine or in combination with any of our other accessories.



COMPACT LIGHT CARRIER CARBON FIBER FINISH

411000CBK *Black*
\$21.99

COMPACT LIGHT CARRIER MATTE FINISH

411000P __ FG, OD, BK, CT
\$20.99



FEATURING REMOVABLE SYSTEM BELT CLIP

LEATHER MAGAZINE POUCHES

The BLACKHAWK!® CQC® single-stack and double-stack magazine pouches not only give you the ability to fit a variety of magazines, with it's integral tension-adjustable screw, but allows you to vary the angle of carry 30 degrees in either direction. Our unique angle-adjustable belt-clip has a very aggressive talon to keep the mag pouch where you want it. The belt clip can even be removed from its mount and the clip-mount will function as a belt loop, with most dress belts. Available for single-stack 9mm, 10mm, .40 cal and .45 cal magazines and for double stack 9mm and .40 cal magazines in both metal and polymer.

SINGLE STACK MAG POUCH	420900BK	BLACK
	420900BN	BROWN NEW!
DOUBLE STACK MAG POUCH	420901BK	BLACK
	420901BN	BROWN NEW!
\$34.99		
DUAL MAG POUCH FOR SINGLE STACK MAGS	420902BK	BLACK NEW!
	420902BN	BROWN NEW!
DUAL MAG POUCH FOR DOUBLE STACK MAGS	420903BK	BLACK NEW!
	420903BN	BROWN NEW!
\$45.99		



MULTI-POSITIONABLE QUICKSNAP BELT ATTACHMENT



TACTICAL MAG POUCH

Carbon Fiber mag pouch with molded flap. This mag pouch screw mounts directly to the SERPA tactical holster platform.
430900BK/CT/FG/OD **\$20.99**



REMOVABLE BELT CLIP



VARY THE ANGLE 30° IN EITHER DIRECTION ON THE SINGLE MAG POUCH



INJECTION MOLDED USING A SUPER STRENGTH GLASS FILLED POLYMER, THESE REPLICAS WILL GIVE YOU YEARS OF SERVICE. ALL MODELS AVAILABLE IN SAFETY ORANGE OR GREY.



DEMONSTRATOR REPLICAS GUNS

For all of those in need of a replica weapon that is the exact size of the real pistol, BLACKHAWK!® Law Enforcement brings you the BLACKHAWK!® Demonstrator weapons. Now you can work with and demonstrate holsters and other pistol accessories with a weapon that is the same size as the real pistol, unlike many other replicas on the market.

GLOCK 17/22/31 SIZED WEAPON IN GREY	44DGGL17GY
GLOCK 17/22/31 SIZED WEAPON IN SAFETY ORANGE	44DGGL17OR
BERETTA 92/96 SIZED WEAPON IN GREY	44DGB92FGY
BERETTA 92/96 SIZED WEAPON IN SAFETY ORANGE	44DGB92FOR
S&W J-FRAME SIZED WEAPON IN GREY	44DGSWJFGY
SIG 226 W/RAIL SIZED WEAPON IN GREY	44DG226RGY
SIG 226 W/RAIL SIZED WEAPON IN SAFETY ORANGE	44DG226ROR
COLT 1911 SIZED WEAPON IN GREY	44DG1911GY
COLT 1911 SIZED WEAPON IN SAFETY ORANGE	44DG1911OR
\$30.99	



DUTY GEAR

BLACKHAWK! LAW ENFORCEMENT IS "DUTY GEAR DONE RIGHT."





18

Ergonomically designed Duty Belt with padded edges. Nylon Loop backing mates to Duty Gear Trousers Belt.

5

Double Mag Pouch available to fit single stack, double stack and even Glock 21 mags. Mounts vertically or horizontally on belt

12

Chemical Agent Pouch available for Mark 3 and Mark 4 canisters. Polymer insert prevents can from denting

SERPA Taser X-26 Level 2 Holster (SEE HOLSTER SECTION)

MADE OF OUR PROPRIETARY 5 LAYER MOLDED CORDURA® NYLON MOLDED CORDURA DUTY GEAR

 Only BLACKHAWK!® has combined the crisp, professional look of molded nylon with the superior abrasion resistance of Cordura®. You've always had to settle for one or the other. Now you can get both. Abrasion is the main enemy of duty gear and regular nylon just doesn't hold up. Cordura® has superior resistance to abrasion, but has always been easy to crush and hasn't always maintained its shape. BLACKHAWK!® has found a way to mold Cordura®, so that you get that great molded look with the toughness of Cordura®.



1. SINGLE MAG POUCH	44A003BK	\$23.99
2. SILENT KEY HOLDER	44A600BK	\$16.99
3. LATEX GLOVE POUCH (MOLDED CORDURA)	44A300BK	\$18.99
4. HANDCUFF POUCH - SINGLE	44A100BK	\$23.99
MAG POUCHES WORK BOTH VERTICALLY AND HORIZONTALLY		
5. DUTY GEAR DOUBLE MAG POUCH - DOUBLE ROW	44A001BK	\$34.99
6. DUTY GEAR DOUBLE MAG POUCH - SINGLE ROW	44A000BK	\$33.99
7. MOLDED BELT KEEPERS (SET OF 4)	44B300BK	\$12.99
8. LIGHT/BATON HOLDER (D CELL & C CELL)	44A201BK	\$9.99
9. TASER CARTRIDGE POUCH	44A800BK	\$24.99 NEW!
10. EXPANDABLE BATON CARRIER	44A700BK	\$18.99
11. RADIO CARRIER - QUICK DISCONNECT SWIVEL BELT LOOP	44A400BK	\$37.99
12. CHEM AGENT - LARGE (MK-4)	44A501BK	\$24.99
13. STINGER LIGHT POUCH	44A203BK	\$31.99 NEW!
14. GLADIUS™ LIGHT POUCH	44A202BK	\$24.99
15. CHEM AGENT - MEDIUM (MK3)	44A500BK	\$21.99
16. DOUBLE MAG POUCH - STAGGERED COLUMN- GLOCK 21	44A002BK	\$35.99
17. TASER CARTRIDGE POUCH	44A800BK	\$24.99 NEW!
18. REINFORCED 2" WEB DUTY BELT WITH LOOP INNER	44B2_ BK	XS, SM, MD, LG, XL, XXL \$36.99

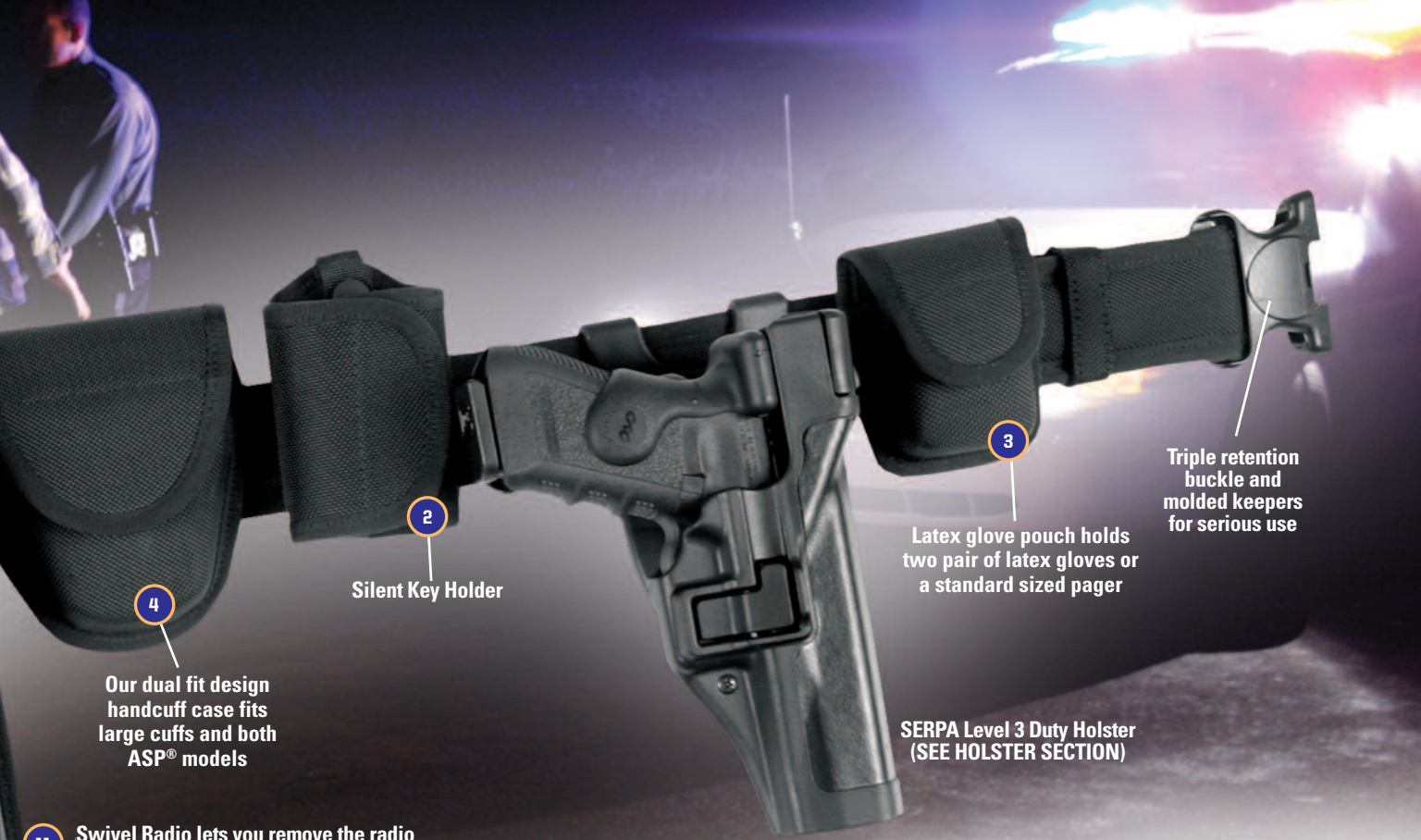

4

Our dual fit design handcuff case fits large cuffs and both ASP® models

2

Silent Key Holder

3

Latex glove pouch holds two pair of latex gloves or a standard sized pager

Triple retention buckle and molded keepers for serious use

SERPA Level 3 Duty Holster (SEE HOLSTER SECTION)

11

Swivel Radio lets you remove the radio case without undoing your belt

7

8



THESE POUCHES ALSO MOUNT ONTO THE DROP LEG PLATFORM. SEE PG 102



32

Ergonomically designed Duty Belt with padded edges. Nylon Loop backing mates to Duty Gear Trousers Belt.

SERPA Level 2 Taser X-26 holster. (SEE HOLSTER SECTION)

6

Fits most standard single and double row metal and polymer mags in 9mm, 40 S&W, 10mm, and .45ACP.

11

Available for both 2" & 2 1/4" Belts. Come in sets of 4

14

Universal Adjustable Radio carrier. Fixed belt loop or quick release swivel belt attachment



MADE OF OUR EXCLUSIVE 4 LAYER LAMINATE OF CORDURA® NYLON TRADITIONAL STYLE NYLON DUTY GEAR

At BLACKHAWK!® we are focused on giving our customers choices where other companies give you limits. To further expand our selection of nylon duty gear, we are offering a more traditional non-molded line of Cordura nylon. You get the same famous abrasion resistance and ability to decontaminate with a simple bleach solution that Cordura nylon is noted for, but at a lower price level than our premium molded Cordura line. Our exclusive four-layer laminate of Cordura® nylon, waterproof closed-cell foam padding, flexible polymer reinforcing layer and 150-denier knit lining used in the non-molded Cordura accessories and our rugged nylon web belts will give you years of service at an easy-on-the-wallet price. Our injection-molded belt loops will fit duty belts up to 2 1/4 inches and many mag pouches will work both vertically and horizontally.

1. OPEN CUFF CASE	44A150BK	\$15.99	19. OPEN KEY HOLDER	44A651BK	\$11.99
2. FLAT CUFF CASE	44A151BK	\$12.99	20. LATEX GLOVE CASE (HOLDS 1 PAIR)	44A350BK	\$10.50
3. SINGLE CUFF CASE	44A153BK	\$17.99	21. LATEX GLOVE CASE (HOLDS 2 PAIR)	44A351BK	\$14.99
4. DOUBLE CUFF CASE	44A152BK	\$21.99	22. LARGE GLOCK MAG/KNIFE CASE	44A052BK	\$15.99
5. STINGER LIGHT CASE	44A251BK	\$16.99	23. MINI LITE CASE W/FLAP	74LC03BK	\$13.05
6. LARGE frame GLOCK DOUBLE MAG CASE W/INSERT	44A053BK	\$30.99	24. UNIVERSAL MAG/knife CASE	44A055BK	\$14.99
7. SINGLE MAGAZINE CASE-SINGLE ROW	44A050BK	\$19.99	25. DIVIDED PISTOL MAG CASE W/INSERTS		
8. SINGLE MAGAZINE CASE-DOUBLE ROW	44A051BK	\$19.99	SINGLE ROW MAGS	44A056BK	\$24.89
9. MAGAZINE/FOLDING KNIFE CASE	44A058BK	\$15.99	DOUBLE ROW MAGS	44A057BK	\$24.89
10. NYLON BELT KEEPERS FITS 2" BELTS (PKG 4)	44B350BK	\$10.72	26. STINGER XT LIGHT CASE	44A252BK	\$16.99
11. NYLON BELT KEEPERS FITS 2 1/4" BELTS (PKG 4)	44B351BK	\$10.72	27. SURE FIRE 6P LIGHT CASE	44A250BK	\$15.99
12. UNIVERSAL DOUBLE MAG CASE	44A054BK	\$22.99	28. CHEMICAL AGENT CASES MEDIUM MK3	44A551BK	\$16.99
13. SILENT KEY HOLDER	44A650BK	\$13.99	29. CHEMICAL AGENT CASES LARGE MK4	44A550BK	\$17.99
14. UNIVERSAL RADIO CARRIER – FIXED BELT LOOP	44A450BK	\$27.99	30. AXON FLIP OPEN POUCH	44A410BK	\$21.99 NEW!
15. UNIVERSAL RADIO CARRIER – SWIVEL BELT LOOP	44A451BK	\$37.99	31. AXON BELT POUCH	44A411BK	\$40.99 NEW!
16. MICROPHONE CARRIER FOR EPAULET	44A455BK	\$9.99	32. REINFORCED 2" WEB DUTY BELT WITH LOOP INNER	44B4_ BK SM, MD, LG, XL, XXL	\$29.32 NEW!
17. TASER CARTRIDGE CASE	44A850BK	\$16.99			
18. EXPANDABLE BATON CASE	44A750BK	\$16.99			



Triple retention buckle and molded keepers for serious use

SERPA Level 3 Light Bearing Duty Holster (SEE HOLSTER SECTION)

21

2 sizes of pouch can hold either one or two pair of latex gloves

Fits belts up to 2-1/4" wide. Works with dress or duty belt

3

Chemical Agent Pouch available for Mark 3 and Mark 4 canisters. Polymer insert prevents can from denting

28

5

Holds 7" size lights, fits belts up to 2-1/4" wide



THESE POUCHES ALSO MOUNT ONTO THE DROP LEG PLATFORM. SEE PG 102



18
Ergonomically designed Duty Belt with padded edges. Nylon Loop backing mates to Duty Gear Trouser Belt.

16
Fits most standard single and double row metal and polymer mags in 9mm, 40 S&W, 10mm, and .45ACP.

1
Chemical Agent Pouch available for Mark 3 and Mark 4 canisters. Polymer insert prevents can from denting

SERPA Level 2 Taser X-26 holster. (SEE HOLSTER SECTION)

10

BASKETWEAVE MOLDED DUTY GEAR



BLACKHAWK!® has done it again, giving you the best of both world's for traditional looking yet street-tough duty gear. We've combined the high performance, light weight and ability to disinfect blood-borne pathogens of nylon and added the traditional look of basketweave leather duty gear. Now your officers can get the back-saving lightness and all-day comfort of nylon with the crisp molded look of leather duty gear. Only BLACKHAWK!® gives you the strength of our proprietary 5-layer laminate with the integral polymer core for long-lasting service life.

1. CHEM AGENT - MEDIUM (MK3)	44A500BW	\$34.99 NEW!
2. SILENT KEY HOLDER	44A600BW	\$27.99 NEW!
3. LATEX GLOVE POUCH	44A300BW	\$28.99 NEW!
4. HANDCUFF POUCH - SINGLE	44A100BW	\$33.99 NEW!
5. DOUBLE MAG POUCH - STAGGERED COLUMN- GLOCK 21	44A002BW	\$45.99 NEW!
6. DUTY GEAR DOUBLE MAG POUCH - SINGLE COLUMN	44A000BW	\$43.99 NEW!
7. LIGHT/BATON HOLDER (D CELL & C CELL)	44A201BK	\$9.99
8. MOLDED BELT KEEPERS (SET OF 4)	44B300BK	\$12.99
9. EXPANDABLE BATON CARRIER	44A700BK	\$29.99 NEW!
10. RADIO POUCH	44A400BW	\$49.99 NEW!
11. CHEM AGENT - LARGE (MK-4)	44A501BW	\$34.99 NEW!
12. STINGER LIGHT POUCH	44A203BW	\$34.99 NEW!
13. GLADIUS™ LIGHT POUCH	44A202BW	\$34.99 NEW!
14. LIGHT POUCH 6P/6R/TL-2/TT-2/M-6	44A200BW	\$31.99 NEW!
MAG POUCHES WORK BOTH VERTICALLY AND HORIZONTALLY		
15. SINGLE MAG POUCH DOUBLE ROW	44A003BW	\$26.99 NEW!
16. DUTY GEAR DOUBLE MAG POUCH - STAGGERED COLUMN	44A001BW	\$44.99 NEW!
17. CHEM AGENT - PUNCH II CANISTER POUCH	44A502BW	\$37.99 NEW!
18. REINFORCED 2" DUTY BELT WITH LOOP INNER	44B4_ BW	SM, MD, LG, XL, XXL \$49.99 NEW!



Handcuff Case

Silent Key Holder

2 sizes of pouch can hold either one or two pair of latex gloves

Triple retention buckle and molded keepers for serious use

SERPA Level 3 Duty Holster (SEE HOLSTER SECTION)

Universal Adjustable Radio carrier. Fixed belt loop or quick release swivel belt attachment

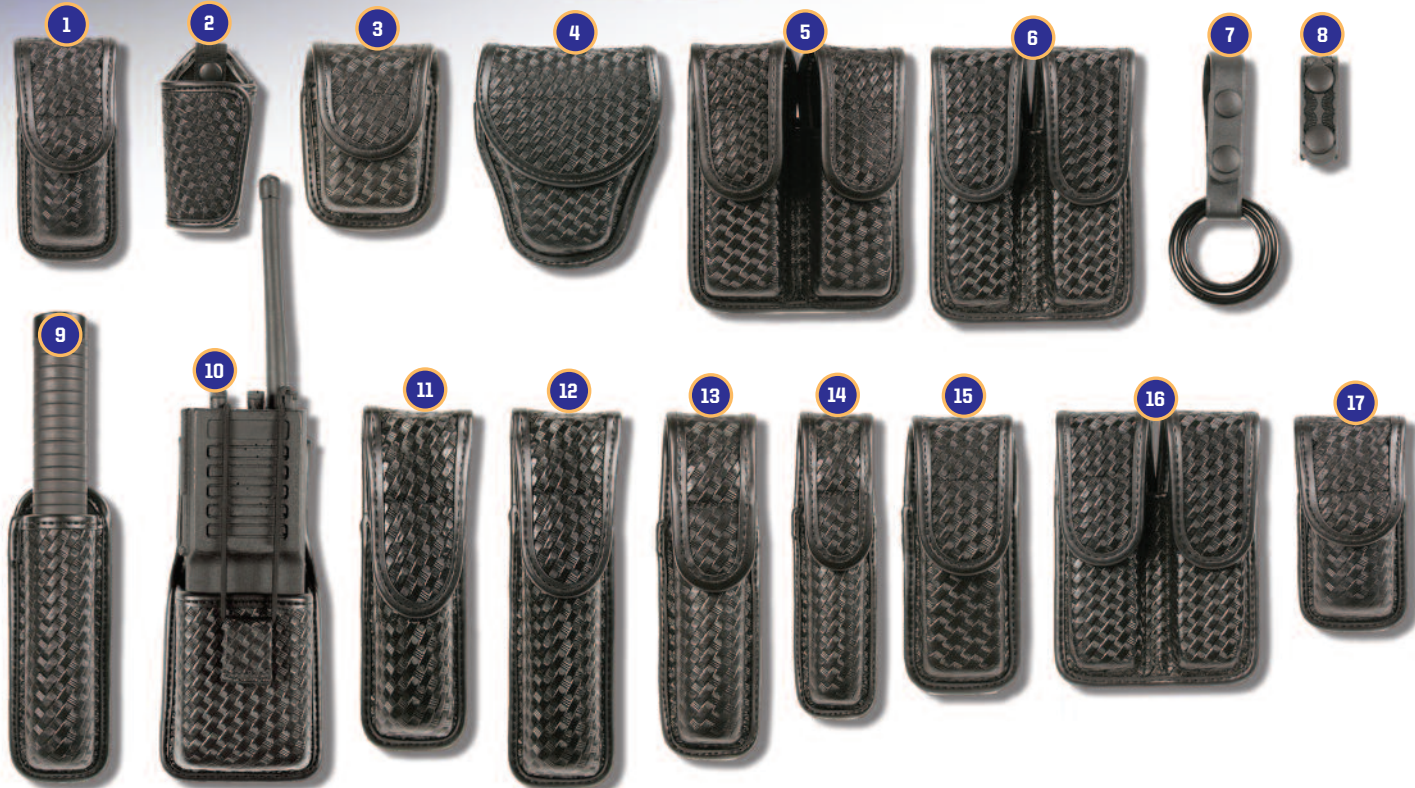



18
Ergonomically designed Duty Belt with padded edges. Nylon Loop backing mates to Duty Gear Trouser Belt.

15
Fits most standard single and double row metal and polymer mags in 9mm, 40 S&W, 10mm, and .45ACP.

6
Chemical Agent Pouch available for Mark 3 and Mark 4 canisters. Polymer insert prevents can from denting

SERPA Level 2 Taser X-26 holster. (SEE HOLSTER SECTION)

2

PLAIN FINISH MOLDED DUTY GEAR



BLACKHAWK!® has done it again, giving you the best of both world's for traditional looking yet street-tough duty gear. We've combined the high performance, light weight and ability to disinfect blood-borne pathogens of nylon and added the traditional look of plain leather duty gear. Now your officers can get the back-saving lightness and all-day comfort of nylon with the crisp molded look of leather duty gear. Only BLACKHAWK!® gives you the strength of our proprietary 5-layer laminate with the integral polymer core for long-lasting service life.

1. CHEM AGENT - PUNCH II CANISTER POUCH	44A502PL	\$37.99 NEW!
2. SILENT KEY HOLDER	44A600PL	\$27.99 NEW!
3. LATEX GLOVE POUCH	44A300PL	\$28.99 NEW!
4. HANDCUFF POUCH - SINGLE	44A100PL	\$33.99 NEW!
5. DUTY GEAR DOUBLE MAG POUCH - DOUBLE ROW	44A001PL	\$44.99 NEW!
6. DUTY GEAR DOUBLE MAG POUCH - SINGLE ROW	44A000PL	\$43.99 NEW!
7. LIGHT/BATON HOLDER (D CELL & C CELL)	44A201BK	\$9.99
8. MOLDED BELT KEEPERS (SET OF 4)	44B300BW	\$15.99
9. EXPANDABLE BATON CARRIER	44A700PL	\$29.99 NEW!
10. RADIO POUCH	44A400PL	\$49.99 NEW!
11. STINGER LIGHT POUCH	44A203PL	\$34.99 NEW!
12. CHEM AGENT - LARGE (MK-4)	44A501PL	\$34.99 NEW!
13. GLADIUS™ LIGHT POUCH	44A202PL	\$34.99 NEW!
MAG POUCHES WORK BOTH VERTICALLY AND HORIZONTALLY		
14. LIGHT POUCH 6P/6R/TL-2/TT-2/M-6	44A200PL	\$31.99 NEW!
15. SINGLE MAG POUCH DOUBLE ROW	44A003PL	\$26.99 NEW!
16. DOUBLE MAG POUCH - STAGGERED COLUMN- GLOCK 21	44A002PL	\$45.99 NEW!
17. CHEM AGENT - MEDIUM (MK3)	44A500PL	\$34.99 NEW!
18. REINFORCED 2" DUTY BELT WITH LOOP INNER	44B4_PL	SM, MD, LG, XL, XXL \$49.99 NEW!



11
Handcuff Case

1
Silent Key Holder

Universal Adjustable Radio carrier. Fixed belt loop or quick release swivel belt attachment

SERPA Level 3 Duty Holster (SEE HOLSTER SECTION)

5
2 sizes of pouch can hold either one or two pair of latex gloves

Triple retention buckle and molded keepers for serious use





GIVE YOUR BACK A BREAK!

BLACKHAWK!® ERGONOMIC DUTY BELT HARNESS

- Harness used to alleviate discomfort caused by the heavy weight of an equipment-laden duty belt
- Broad range fit for any type of body armor or body type
- No need to buy specific armor packages
- No moving parts to fail
- Duty shirt will need to be modified with slot openings on the side

44H001BK	BLACK	SM/MD	\$79.99	NEW!
44H002BK	BLACK	LG/XL	\$79.99	



DUTY BELT NOT INCLUDED



REMOVABLE BELT KEEPERS ATTACH HARNESS TO DUTY BELT



ADJUSTABLE LADDERLOCK BUCKLE TO RELEASE TENSION



TOP SHOULDER HARNESS ADJUSTS FOR COMFORT AND FIT

ACADEMY/DEMO BELT

This belt has been requested by so many training academies and instructors that we now produce it for our customers. No more not having enough of the right belt sizes for your academy class or shooting course. **This belt fits ALL your students and provides enough support for the heaviest pistols and all the equipment needed.** Ideal for defensive tactics classes, handgun courses and anything where you need to fit a wide variety of size individuals and don't want to stock lots of extra belts so you can fit everyone.

44B00BK	BLACK	ONE SIZE	\$29.99	NEW!
---------	-------	----------	---------	-------------



61.5" FULLY ADJUSTABLE HOOK AND LOOP REINFORCED DEMO BELT

REINFORCED 2" DUTY BELT WITH LOOP INNER

All of the great features of our Reinforced Web Duty Belt plus the addition of a nylon loop inner surface to mate up with the nylon hook of our inner duty belts means more stability for your duty belt and more secure mounting of your accessories.

44B4_BK	WEB	SM, MD, LG, XL, XXL	\$29.32	NEW!
44B4_BW	BASKETWEAVE	SM, MD, LG, XL, XXL	\$49.99	
44B4_PL	PLAIN	SM, MD, LG, XL, XXL	\$49.99	





ERGONOMIC PADDED DUTY BELT (MOLDED CORDURA®)

Ergonomically designed Duty Belt with padded edges. Nylon Loop backing mates to Duty Gear Trouser Belt.

XSMALL FITS SIZES 22-24, SMALL FITS SIZES 26-30, MEDIUM FITS SIZES 32-36, LARGE FITS SIZES 38-42, XLARGE FITS SIZES 44-48, XXLARGE FITS SIZES 50-54

44B2__BK PLAIN XS, SM, MD, LG, XL, XXL **\$36.99**



TRIPLE RELEASE RETENTION BUCKLE



LOOPBACK INNER BELT

The Loopback Inner Duty Belt gives you an easy-to-use and comfortable inner belt. The woven nylon hook mates up to the nylon loop on the inside of many duty belts for added stability or reverse the belt for courtroom wear without the duty belt. The nylon loopback buckle lets you easily adjust the size and the low profile design increases comfort.

44B5__BK BLACK SM, MD, LG, XL **\$14.67**

BLACKHAWK!® INNER DUTY BELT – HOOK AND LOOP CLOSURE

Nylon web inner belts fasten with nylon hook and loop.

44B7__BK BLACK SM, MD, LG, XL **\$12.65**



2" WEB DUTY BELT

This double layer web duty belt gives you strong performance at a budget price. It includes a triple retention buckle and molded keepers for serious use.

44B6__BK BLACK SM, MD, LG, XL **\$21.99**

TROUSER BELT (INNER BELT)

Molded nylon loop hook will not fray belt loops or trousers. Full-length nylon hook on one side mates with the nylon loop of many duty belts to increase stability. Simply reverse the belt for courtroom wear without duty belt.

XSMALL FITS SIZES 22-24, SMALL FITS SIZES 26-30, MEDIUM FITS SIZES 32-36, LARGE FITS SIZES 38-42, XLARGE FITS SIZES 44-48, XXLARGE FITS SIZES 50-54

44B1__BK BLACK XS, SM, MD, LG, XL, XXL **\$21.99**



MOLDED NYLON HOOK WON'T FRAY BELT LOOPS OR TROUSERS



REINFORCED 2" WEB DUTY BELT

Great performance at a great price. Two layers of nylon web are reinforced with a polymer spine for durability and strength. The nylon binding provides a smoother edge, more comfort and a more professional appearance. Plus the binding reduces the abrasion from the edge of the belt and the triple lock buckle helps prevent accidental opening or someone stripping your belt.

44B3__BK BLACK SM, MD, LG, XL **\$27.36**